



TEST REPORT IEC 62109-2 Safety of Power Converter for use in Photovoltaic Power Systems Part 2: Particular requirements for inverters	
Report Number	210901903SHA-002
Date of issue	2021-12-24
Total number of pages	26 Pages
Name of Testing Laboratory preparing the Report	Intertek Testing Services Shanghai Building No.86, 1198 Qinzhou Road (North), Shanghai 200233, China
Applicant's name	Afore New Energy Technology (Shanghai) Co., Ltd
Address	Build No.7, 333 Wanfang Road, Minhang District, Shanghai. China. 201112
Test specification:	
Standard	IEC/EN 62109-2:2011
Test procedure	CE-LVD
Non-standard test method	N/A
Test Report Form No.	IEC62109_2B
Test Report Form(s) Originator	LCIE - Laboratoire Central des Industries Electriques
Master TRF	Dated 2016-11
Copyright © 2016 IEC System of Conformity Assessment Schemes for Electrotechnical Equipment and Components (IECEE System). All rights reserved. This publication may be reproduced in whole or in part for non-commercial purposes as long as the IECEE is acknowledged as copyright owner and source of the material. IECEE takes no responsibility for and will not assume liability for damages resulting from the reader's interpretation of the reproduced material due to its placement and context.	

item description:	PV Grid interactive inverter
Trade Mark	Afore
Manufacturer	Same as applicant
Model/Type reference	BNT003KTL, BNT004KTL, BNT005KTL, BNT006KTL, BNT008KTL, BNT010KTL, BNT012KTL, BNT013KTL, BNT015KTL, BNT017KTL, BNT020KTL, BNT025KTL
Ratings	See Specifications table in report of 210901903SHA -001

Responsible Testing Laboratory (as applicable), testing procedure and testing location(s):		
<input checked="" type="checkbox"/>	Testing Laboratory:	Intertek Testing Services Shanghai
Testing location/ address		Building No.86, 1198 Qinzhou Road (North), Shanghai 200233, China
<input type="checkbox"/>	Associated CB Testing Laboratory:	
Testing location/ address		
Tested by (name, function, signature)		Chuanhui Xie (Engineer) <i>Chuanhui Xie</i>
Approved by (name, function, signature) ..		Sleif Sui (Mandated Reviewer) <i>Sleif Sui</i>
<input type="checkbox"/>	Testing procedure: CTF Stage 1:	
Testing location/ address		
Tested by (name, function, signature)		
Approved by (name, function, signature) ..		
<input type="checkbox"/>	Testing procedure: CTF Stage 2:	
Testing location/ address		
Tested by (name + signature)		
Witnessed by (name, function, signature) . :		
Approved by (name, function, signature) .. :		
<input type="checkbox"/>	Testing procedure: CTF Stage 3:	
<input type="checkbox"/>	Testing procedure: CTF Stage 4:	
Testing location/ address		
Tested by (name, function, signature)		
Witnessed by (name, function, signature) . :		
Approved by (name, function, signature) .. :		
Supervised by (name, function, signature) :		

List of Attachments (including a total number of pages in each attachment):	
Summary of testing: All tests were carried out according to IEC 62109-2:2011.	
Tests performed (name of test and test clause): <input checked="" type="checkbox"/> 4.4.4 Testing in single fault condition <input type="checkbox"/> 4.7.4 Stand-alone Inverter AC output voltage and frequency <input type="checkbox"/> 4.7.5 Stand-alone inverter output voltage waveform <input checked="" type="checkbox"/> 4.8.2 Array insulation resistance detection for inverters for ungrounded and functionally grounded arrays <input checked="" type="checkbox"/> 4.8.3 Array residual current detection	Testing location: Building No.86, 1198 Qinzhou Road (North), Shanghai 200233, China
Summary of compliance with National Differences (List of countries addressed): N/A <input checked="" type="checkbox"/> The product fulfils the requirements of IEC/EN 62109-2:2011	

Copy of marking plate:

The artwork below may be only a draft. The use of certification marks on a product must be authorized by the respective NCBs that own these marks.

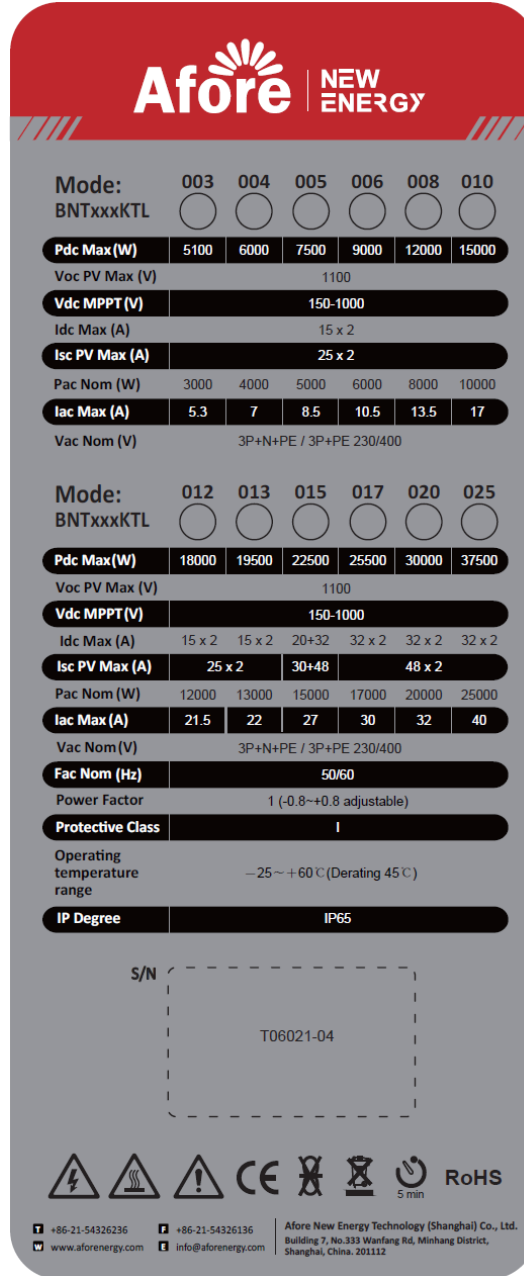

Series No.

T622500032149820

Remark:

1. Printed symbols shall be at least 2.75 mm high. Printed text characters shall be at least 1.5 mm high, whether upper case or lower case, and shall contrast in colour with the background
2. The tenth to thirteenth of the serial number (2149): 21=year 49=week.

Warning marking

WARNING



Hot surfaces
To reduce the risk of burns. Do not touch.



Risk of electric shock
Both AC and DC voltage sources are terminated inside this equipment. Each circuit must be individually disconnected before servicing and when the photovoltaic array is exposed to light, it supplies a DC voltage to this equipment.



Risk of electric shock from energy stored in capacitor. Do not remove cover until 5 minutes after disconnecting all sources of supply.



Risk of electric shock, do not remove cover. No user serviceable parts inside. Refer servicing to qualified service personnel.



Check user manual before service
Refer to the operation instruction.



NO warranty for disassembled inverter
Warranty doesn't provide for the inverter disassembled by non-authorized staff.



WARNING:

POWER FED FROM MORE THAN ONE SOURCE

For continued protection against risk of fire, replace only with same type and ratings of fuse.



Electronic Materials

Please scan the QR code below with your mobile phone to obtain relevant electronic information.

MONITORING APP





75AD-0036/V0.01

e USER MANUAL



Test item particulars	
Equipment mobility	<input type="checkbox"/> movable <input type="checkbox"/> hand-held <input type="checkbox"/> stationary <input checked="" type="checkbox"/> fixed <input type="checkbox"/> transportable <input type="checkbox"/> for building-in
Connection to the mains	<input type="checkbox"/> pluggable equipment <input type="checkbox"/> direct plug-in <input checked="" type="checkbox"/> permanent connection <input type="checkbox"/> for building-in
Environmental category	<input checked="" type="checkbox"/> outdoor <input type="checkbox"/> indoor unconditional <input type="checkbox"/> indoor conditional
Over voltage category Mains	<input type="checkbox"/> OVC I <input type="checkbox"/> OVC II <input checked="" type="checkbox"/> OVC III <input type="checkbox"/> OVC IV
Over voltage category PV	<input type="checkbox"/> OVC I <input checked="" type="checkbox"/> OVC II <input type="checkbox"/> OVC III <input type="checkbox"/> OVC IV
Mains supply tolerance (%)	-90 / +110 %
Tested for power systems	TN
IT testing, phase-phase voltage (V)	- - -
Class of equipment	<input checked="" type="checkbox"/> Class I <input type="checkbox"/> Class II <input type="checkbox"/> Class III <input type="checkbox"/> Not classified
Mass of equipment (kg)	Max. 19 KG
Pollution degree	PD3 (PD2 internal)
IP protection class	IP65
.....	
Possible test case verdicts:	
- test case does not apply to the test object	N/A
- test object does meet the requirement	P (Pass)
- test object does not meet the requirement	F (Fail)
Testing	
Date of receipt of test item	2021-08-24
Date (s) of performance of tests	2021-08-25 to 2021-12-05

General remarks:	
<p>"(See Enclosure #)" refers to additional information appended to the report. "(See appended table)" refers to a table appended to the report.</p> <p>Throughout this report a <input type="checkbox"/> comma / <input checked="" type="checkbox"/> point is used as the decimal separator.</p> <p>Standard IEC/EN 62109-2:2011 is to be used in conjunction with IEC/EN 62109-1:2010.</p> <p>The test results presented in this report relate only to the item tested. The results indicate that the specimen complies with standards" IEC/EN 62109-1:2010 and IEC/EN 62109-2:2011".</p> <p>Determination of the test conclusion is based on IEC Guide 115 in consideration of measurement uncertainty.</p> <p>This report is for the exclusive use of Intertek's Client and is provided pursuant to the agreement between Intertek and its Client. Intertek's responsibility and liability are limited to the terms and conditions of the agreement. Intertek assumes no liability to any party, other than to the Client in accordance with the agreement, for any loss, expense or damage occasioned by the use of this report. Only the Client is authorized to permit copying or distribution of this report and then only in its entirety. Any use of the Intertek name or one of its marks for the sale or advertisement of the tested material, product or service must first be approved in writing by Intertek. The observations and test results in this report are relevant only to the sample tested. This report by itself does not imply that the material, product, or service is or has ever been under an Intertek certification program.</p>	
Manufacturer's Declaration per sub-clause 4.2.5 of IECEE 02:	
<p>The application for obtaining a CB Test Certificate includes more than one factory location and a declaration from the Manufacturer stating that the sample(s) submitted for evaluation is (are) representative of the products from each factory has been provided..... :</p>	<p><input type="checkbox"/> Yes</p> <p><input checked="" type="checkbox"/> Not applicable</p>
When differences exist; they shall be identified in the General product information section.	
<p>Name and address of factory (ies).....: Same as applicant</p>	

General product information:

The testing unit is a Class I grid-interactive PV inverter for outdoor installation (IP65).
 The unit is providing EMC filtering at the output toward mains.
 The unit does not provide galvanic separation from input to output (transformerless).
 The output is switched off redundant by the high power switching bridge and two relays. This assures that the opening of the output circuit will also operate in case of one is error.

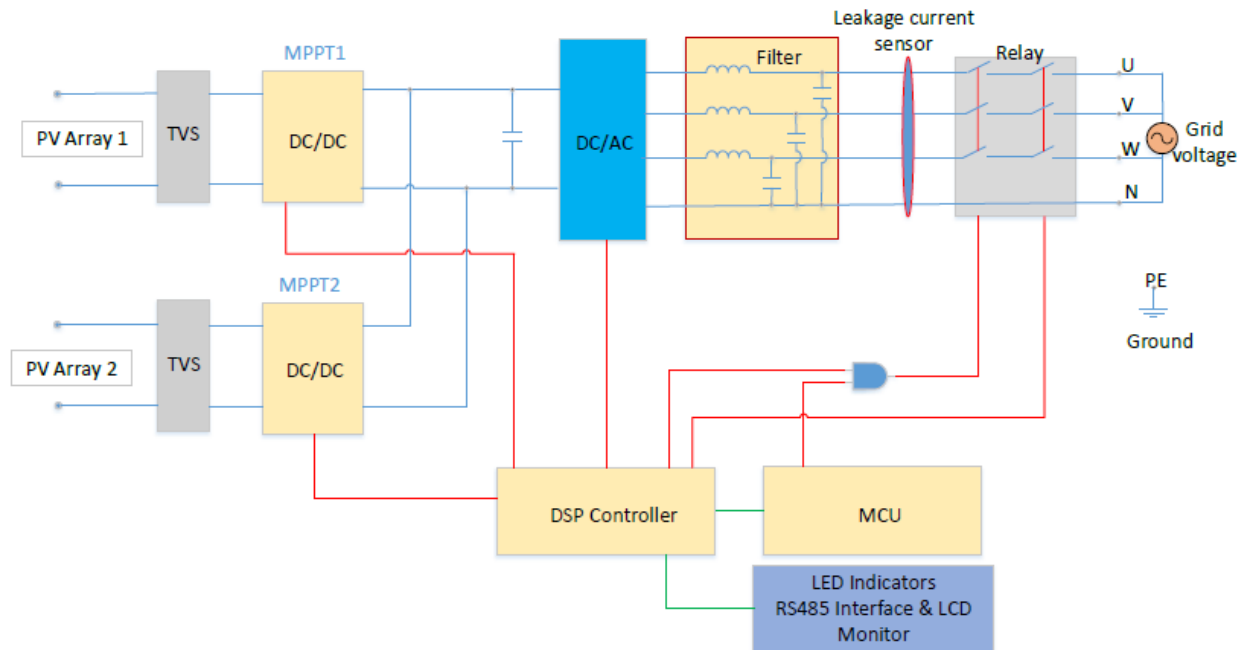

The product was tested on Software version:

- CPU1: DSP V06
- CPU2: CPLD V06
- CPU3(Communication): HMI V06

Model difference:

All models have same circuit, PWB layout and software. And difference between models are output rating, PV input string number and fan number.

Model BNT003KTL, BNT004KTL, BNT005KTL, BNT006KTL, BNT008KTL, BNT010KTL, BNT012KTL, BNT013KTL have 2 PV input strings.

Model BNT015KTL have 3 PV input strings

Model BNT017KTL, BNT020KTL, BNT025KTL have 4 PV input strings.

Model BNT003KTL, BNT004KTL, BNT005KTL, BNT006KTL have no external fan.

Model BNT008KTL, BNT010KTL, BNT012KTL have 1 external fan.

Model BNT013KTL, BNT015KTL, BNT017KTL, BNT020KTL, BNT025KTL have 2 external fans.

The output power is derated by software.

Except as noted, the model BNT25KTL is as the representative test model in this report.

IEC 62109-2			
Clause	Requirement + Test	Result - Remark	Verdict
4	GENERAL TESTING REQUIREMENTS		P
4.4.4	Single fault conditions to be applied		P
4.4.4.15	Fault-tolerance of protection for grid-interactive inverters		P
4.4.4.15.1	Fault-tolerance of residual current monitoring according to 4.8.3.5: the residual current monitoring system operates properly		P
	a) . - The inverter ceases to operate		P
	- Indicates a fault in accordance with §13.9		P
	- Disconnect from the mains		P
	- not re-connect after any sequence of removing and reconnecting PV power		P
	- not re-connect after any sequence of removing and reconnecting AC power		P
	- not re-connect after any sequence of removing and reconnecting both PV and AC power		P
	b) . - The inverter continues to operate		N/A
	- the residual current monitoring system operates properly under single fault condition		N/A
	- Indicates a fault in accordance with §13.9		N/A
	c) . - The inverter continues to operate regardless of loss of residual current monitoring functionality		N/A
	- not re-connect after any sequence of removing and reconnecting PV power		N/A
	- not re-connect after any sequence of removing and reconnecting AC power		N/A
	- not re-connect after any sequence of removing and reconnecting both PV and AC power		N/A
	- Indicates a fault in accordance with §13.9		N/A
4.4.4.15.2	Fault-tolerance of automatic disconnecting means	Relay	P
4.4.4.15.2.1	The means provided for automatic disconnection of a grid-interactive inverter from the mains shall:		P
	- disconnect all grounded current-carrying conductors from the mains		P
	- disconnect all ungrounded current-carrying conductors from the mains		P
	- be such that with a single fault applied to the disconnection means or to any other location in the inverter, at least basic insulation or simple separation is maintained between the PV array and the mains when the disconnecting means is intended to be in the open state.	See appended table 4.4.4.15.2 Fault-tolerance of automatic disconnecting	P
4.4.4.15.2.2	Design of insulation or separation complies with requirements of 7.3.7 of Part 1: report here Part 1 comment and verdict.		P
4.4.4.15.2.3	For non-isolated inverter, automatic checking of the isolation provided by a disconnect means after single fault.	See appended test table 4.4.4.15.2 Fault-tolerance of automatic disconnecting.	P
	If the check fail:		P
	- any still-functional disconnection means shall be left in the open position		P
	- at least basic or simple separation shall be		P

IEC 62109-2			
Clause	Requirement + Test	Result - Remark	Verdict
	maintained between the PV input and the mains		
	- the inverter shall not start operation		P
	- the inverter shall indicate a fault in accordance with 13.9		P
4.4.4.16	A stand-alone inverter with a transfer switch to transfer AC loads from the mains or other AC bypass source to the inverter output:	Grid-Interactive inverter	N/A
	- shall continue to operate normally		N/A
	- shall not present a risk of fire as the result of an out-of-phase transfer		N/A
	- shall not present a risk of shock as the result of an out-of-phase transfer		N/A
	- And having control preventing switching: components for malfunctioning		N/A
4.4.4.17	Cooling system failure – Blanketing test No hazards according to the criteria of sub-clause 4.4.3 of Part 1 shall result from blanketing the inverter This test is not required for inverters restricted to use only in closed electrical operating areas.	See appended test table Cooling system failure – Blanketing test.	P
	Test stop condition: time duration value or stabilized temperature	stabilized temperature	P
4.7	ELECTRICAL RATINGS TESTS		N/A
4.7.4	Stand-alone Inverter AC output voltage and frequency		N/A
4.7.4.1	General	Grid-Interactive inverter	N/A
4.7.4.2	Steady state output voltage at nominal DC input The steady-state AC output voltage shall not be less than 90 % or more than 110 % of the rated nominal voltage with the inverter supplied with its nominal value of DC input voltage.		N/A
4.7.4.3	Steady state output voltage across the DC input range The steady-state AC output voltage shall not be less than 85 % or more than 110 % of the rated nominal voltage with the inverter supplied with any value within the rated range of DC input voltage.		N/A
4.7.4.4	Load step response of the output voltage at nominal DC input The AC output voltage shall not be less than 85 % or more than 110 % of the rated nominal voltage for more than 1,5 s after application or removal of a resistive load.		N/A
4.7.4.5	Steady state output frequency The steady-state AC output frequency shall not vary from the nominal value by more than +4 % or –6 %.		N/A
4.7.5	Stand-alone inverter output voltage waveform		N/A
4.7.5.1	General		N/A
4.7.5.2	The AC output voltage waveform of a sinusoidal output stand-alone inverter shall have a total harmonic distortion (THD) not exceeding of 10 % and no individual harmonic at a level exceeding 6 %.		N/A
4.7.5.3	Non-sinusoidal output waveform requirements		N/A
4.7.5.3.1	General		N/A

IEC 62109-2			
Clause	Requirement + Test	Result - Remark	Verdict
4.7.5.3.2	The total harmonic distortion (THD) of the voltage waveform shall not exceed 40 %.		N/A
4.7.5.3.3	The slope of the rising and falling edges of the positive and negative half-cycles of the voltage waveform shall not exceed 10 V/ μ s measured between the points at which the waveform has a voltage of 10 % and 90 % of the peak voltage for that half-cycle.		N/A
4.7.5.3.4	The absolute value of the peak voltage of the positive and negative half-cycles of the waveform shall not exceed 1,414 times 110 % of the RMS value of the rated nominal AC output voltage.		N/A
4.7.5.4	Information requirements for non-sinusoidal waveforms The instructions provided with a stand-alone inverter not complying with 4.7.5.2 shall include the information in 5.3.2.6.		N/A
4.7.5.5	Output voltage waveform requirements for inverters for dedicated loads. For an inverter that is intended only for use with a known dedicated load, the following requirements may be used as an alternative to the waveform requirements in 4.7.5.2 to 4.7.5.3.		N/A
	The combination of the inverter and dedicated load shall be evaluated to ensure that the output waveform does not cause any hazards in the load equipment and inverter, or cause the load equipment to fail to comply with the applicable product safety standards.		N/A
	The inverter shall be marked with symbols 9 and 15 of Table C.1 of Part 1.		N/A
	The installation instructions provided with the inverter shall include the information in 5.3.2.13.		N/A
4.8	ADDITIONAL TESTS FOR GRID-INTERACTIVE INVERTERS		P
4.8.1	General requirements regarding inverter isolation and array grounding	No-Isolated	N/A
	- Type of Array grounding supported		N/A
	- Inverter isolation		N/A
4.8.2	Array insulation resistance detection for inverters for ungrounded and functionally grounded arrays	(See attached table)	P
4.8.2.1	Array insulation resistance detection for inverters for ungrounded arrays		P
	Inverter shall have means to measure DC insulation resistance from PV input (array) to ground before starting operation,		P
	Or Inverter shall be provided with instruction in accordance with 5.3.2.11.		N/A
	Measured DC insulation resistance:		P
	Inverter measurement circuit shall be capable of detecting insulation resistance below the limit value $R = V_{max}/30mA$ under normal conditions		P
	Inverter measurement circuit shall be capable of detecting insulation resistance below the limit value $R = V_{max}/30mA$ with ground fault in the PV array		P
	Isolated inverters shall indicate a fault if the insulation resistance is less than the limit value		N/A

IEC 62109-2			
Clause	Requirement + Test	Result - Remark	Verdict
	Isolated inverter fault indication maintained until insulation resistance has recovered to a value higher than the limit value		N/A
	Non-isolated inverters, or inverters with isolation not complying with the leakage current limits in the minimum inverter isolation requirements in Table 30:		P
	- shall indicate a fault in accordance with 13.9		P
	- shall not connect to the mains		P
4.8.2.2	Array insulation resistance detection for inverters for functionally grounded arrays	No functionally grounded arrays	N/A
	a-1) The value of the total resistance, including the intentional resistance for array functional grounding, the expected insulation resistance of the array to ground, and the resistance of any other networks connected to ground (for example measurement networks) must not be lower than $R = (V_{MAX} PV/30 \text{ mA})$ ohms.		N/A
	a-2) The installation instructions shall include the information required in 5.3.2.12.		N/A
	b-1) As an alternative to a), or if a resistor value lower than in a) is used, the inverter shall incorporate means to detect, during operation, if the total current through the resistor and any networks (for example measurement networks) in parallel with it, exceeds the residual current values and times in Table 31		N/A
	b-2) Inverter shall either disconnect the resistor or limit the current by other means		N/A
	b-3) If the inverter is a non-isolated inverter, or has isolation not complying with the leakage current limits in the minimum inverter isolation requirements in Table 30, it shall also disconnect from the mains.		N/A
	c) The inverter shall have means to measure the DC insulation resistance from the PV input to ground before starting operation, in accordance with 4.8.2.1.		N/A
4.8.3	Array residual current detection		P
4.8.3.1	General		P
4.8.3.2	30 mA touch current type test for isolated inverters		N/A
4.8.3.3	Fire hazard residual current type test for isolated inverters		N/A
4.8.3.4	Protection by application of RCD's	Without such function.	N/A
	- The requirement for additional protection in 4.8.3.1 can be met by provision of an RCD with a residual current setting of 30 mA, located between the inverter and the mains.		
	- The selection of the RCD type to ensure compatibility with the inverter must be made according to rules for RCD selection in Part 1.		N/A
	- The RCD provided integral to the inverter, or		N/A
	- The RCD provided by the installer if details of the rating, type, and location for the RCD are given in the installation instructions per 5.3.2.9.		N/A
4.8.3.5	Protection by residual current monitoring		P
4.8.3.5.1	General		P
	Where required by Table 30, the inverter shall provide		P

IEC 62109-2			
Clause	Requirement + Test	Result - Remark	Verdict
	residual current monitoring that functions whenever the inverter is connected to the mains with the automatic disconnection means closed.		
	The residual current monitoring means shall measure the total (both a.c. and d.c. components) RMS current.		P
	As indicated in Table 30 for different inverter types, array types, and inverter isolation levels, detection may be required for excessive continuous residual current, excessive sudden changes in residual current, or both, according to the following limits:		P
	a) Continuous residual current: The inverter shall disconnect within 0,3 s and indicate a fault in accordance with 13.9 if the continuous residual current exceeds:		P
	- maximum 300 mA for inverters with continuous output power rating ≤ 30 kVA;		P
	- maximum 10 mA per kVA of rated continuous output power for inverters with continuous output power rating > 30 kVA.		N/A
	The inverter may attempt to re-connect if the array insulation resistance meets the limit in 4.8.2.		P
	b) Sudden changes in residual current: The inverter shall disconnect from the mains within the time specified in Table 31		P
	The inverter indicates a fault in accordance with 13.9, if a sudden increase in the RMS residual current is detected exceeding the value in the table.		P
	The inverter may attempt to re-connect if the array insulation resistance meets the limit in 4.8.2.		P
4.8.3.5.2	Test for detection of excessive continuous residual current: test repeated 5 times and time to disconnect shall not exceed 0,3 s.	See appended test table 4.8.3.5.2 Test for detection of excessive continuous residual current	P
4.8.3.5.3	Test for detection of sudden changes in residual current repeated 5 times and each of the 5 results shall not exceed the time limit indicated in for each row (30mA, 60mA and 150mA) of Table 31.		P
4.8.3.6	Systems located in closed electrical operating areas		N/A
	The protection against shock hazard is not required if the installation information provided with the inverter indicates the restriction for use in a closed electrical operating area, and		N/A
	Installation information indicates what forms of shock hazard protection are and are not provided integral to the inverter, in accordance with 5.3.2.7.		N/A
	The inverter shall be marked as in 5.2.2.6.		N/A
5	MARKING AND DOCUMENTATION		P
5.1	Marking		P
5.1.4	Equipment ratings		P
	PV input ratings:		P
	- Vmax PV (absolute maximum) (d.c. V)		P
	- Isc PV (absolute maximum) (d.c. A)		P
	a.c. output ratings:		P
	- Voltage (nominal or range) (a.c. V)		P

IEC 62109-2			
Clause	Requirement + Test	Result - Remark	Verdict
	- Current (maximum continuous) (a.c. A)		P
	- Frequency (nominal or range) (Hz)		P
	- Power (maximum continuous) (W or VA)		P
	- Power factor range		P
	a.c input ratings:	No a.c. input	N/A
	- Voltage (nominal or range) (a.c. V)		N/A
	- Current (maximum continuous) (a.c. A)		N/A
	- Frequency (nominal or range) (Hz)		N/A
	d.c. output ratings:	No d.c output	N/A
	- Voltage (nominal or range) (d.c. V)		N/A
	- Current (maximum continuous) (d.c. A)		N/A
	Protective class (I or II or III)		P
	Ingress protection (IP) rating per part 1		P
	An inverter that is adjustable for more than one nominal output voltage shall be marked to indicate the particular voltage for which it is set when shipped from the factory.		N/A
5.2	Warning markings		P
5.2.2	Content for warning markings		P
5.2.2.6	Inverters for closed electrical operating areas		N/A
	Where required by 4.8.3.6, an inverter not provided with full protection against shock hazard on the PV array shall be marked with a warning that the inverter is only for use in a closed electrical operating area, and referring to the installation instructions.		N/A
5.3	Documentation		P
5.3.2	Information related to installation		P
5.3.2.1	Ratings. Subclause 5.3.2 of Part 1 requires the documentation to include ratings information for each input and output. For inverters this information shall be as in Table 33 below. Only those ratings that are applicable based on the type of inverter are required.		P
	PV input quantities:		P
	- Vmax PV (absolute maximum) (d.c. V)		P
	- PV input operating voltage range (d.c. V)		P
	- Maximum operating PV input current (d.c. A)		P
	- Isc PV (absolute maximum) (d.c. A)		P
	- Max. inverter backfeed current to the array (a.c. or d.c. A)	0A	P
	a.c. output quantities:		P
	- Voltage (nominal or range) (a.c. V)		P
	- Current (maximum continuous) (a.c. A)		P
	- Current (inrush) (a.c. A, peak and duration)		P
	- Frequency (nominal or range) (Hz)		P
	- Power (maximum continuous) (W or VA)		P
	- Power factor range		P
	- Maximum output fault current (a.c. A, peak and duration or RMS)		P
	- Maximum output overcurrent protection (a.c. A)		P
	a.c. input quantities:		N/A
	- Voltage (nominal or range) (a.c. V)		N/A
	- Current (maximum continuous) (a.c. A)		N/A

IEC 62109-2			
Clause	Requirement + Test	Result - Remark	Verdict
	- Current (inrush) (a.c. A, peak and duration)		N/A
	- Frequency (nominal or range) (Hz)		N/A
	d.c input (other than PV) quantities:		N/A
	- Voltage (nominal or range) (d.c. V)		N/A
	- Nominal battery voltage (d.c. V)		N/A
	- Current (maximum continuous) (d.c. A)		N/A
	d.c. output quantities:		N/A
	- Voltage (nominal or range) (d.c. V)		N/A
	- Nominal battery voltage (d.c. V)		N/A
	- Current (maximum continuous) (d.c. A)		N/A
	Protective class (I or II or III)		P
	Ingress protection (IP) rating per part 1		P
5.3.2.2	Grid-interactive inverter setpoints		N/A
	For a grid-interactive unit with field adjustable trip points, trip times, or reconnect times, the presence of such controls, the means for adjustment, the factory default values, and the limits of the ranges of adjustability shall be provided in the documentation for the PCE or in other format such as on a website. Provided solution:	Non-adjustable to operator, Pre-set by manufacturer before shipment	N/A
	The setting of field adjustable setpoints shall be accessible from the PCE		N/A
5.3.2.3	Transformers and isolation		N/A
	Whether an internal isolation transformer is provided, and if so, what level of insulation (functional, basic, reinforced, or double) is provided by that transformer. The instructions shall also indicate what the resulting installation requirements are regarding such things as earthing or not earthing the array, providing external residual current detection devices, etc.	No transformer between PV and AC main	N/A
	An inverter shall be provided with information to the installer regarding:		N/A
	- providing of internal isolation transformer		N/A
	- the level of insulation (functional, basic, reinforced, or double)		N/A
	The instructions shall also indicate what the resulting installation requirements are regarding:		N/A
	- earthing or not earthing the array		N/A
	- providing external residual current detection devices		N/A
	- requiring an external isolation transformer,		N/A
5.3.2.4	Transformers required but not provided		N/A
	An inverter that requires an external isolation transformer not provided with the unit, shall be provided with instructions that specify, and for the external isolation transformer with which it is intended to be used:		N/A
	- the configuration type		N/A
	- electrical ratings		N/A
	- environmental ratings		N/A
5.3.2.5	PV modules for non-isolated inverters		P
	Non-isolated inverters shall be provided with installation instructions that require PV modules that have an IEC 61730 Class A rating		P

IEC 62109-2			
Clause	Requirement + Test	Result - Remark	Verdict
	If the maximum AC mains operating voltage is higher than the PV array maximum system voltage, then the instructions shall require PV modules that have a maximum system voltage rating based upon the AC mains voltage.		N/A
5.3.2.6	Non-sinusoidal output waveform information		N/A
	The instruction manual for a stand-alone inverter not complying with 4.7.5.2 shall include a warning that:		N/A
	- the waveform is not sinusoidal,		N/A
	- some loads may experience increased heating,		N/A
	- the user should consult the manufacturers of the intended load equipment before operating that load with the inverter		N/A
	The inverter manufacturer shall provide information regarding:		-
	- what types of loads may experience increased heating		N/A
	- recommendations for maximum operating times with such loads		N/A
	The inverter manufacturer shall specify for the waveforms as determined by the testing in 4.7.5.3.2 through 4.7.5.3.4.:		-
	- THD		N/A
	- slope		N/A
	- peak voltage		N/A
5.3.2.7	Systems located in closed electrical operating areas		N/A
	Where required by 4.8.3.6, an inverter not provided with full protection against shock hazard on the PV array shall be provided with installation instructions:		N/A
	- requiring that the inverter and the array must be installed in closed electrical operating areas		N/A
	- indicating which forms of shock hazard protection are and are not provided integral to the inverter (for example the RCD, isolation transformer complying with the 30 mA touch current limit, or residual current monitoring for sudden changes)		N/A
5.3.2.8	Stand-alone inverter output circuit bonding		N/A
	Where required by 7.3.10, the documentation for an inverter shall include the following:		N/A
	- if output circuit bonding is required but is not provided integral to the inverter, the required means shall be described in the installation instructions, including which conductor is to be bonded and the required current carrying capability or cross-section of the bonding means;		N/A
	- if the output circuit is intended to be floating, the documentation for the inverter shall indicate that the output is floating.		N/A
5.3.2.9	Protection by application of RCD's		N/A
	Where the requirement for additional protection in 4.8.3.1 is met by requiring an RCD that is not provided integral to the inverter, as allowed by 4.8.3.4, the installation instructions shall state the need for the RCD,		N/A

IEC 62109-2			
Clause	Requirement + Test	Result - Remark	Verdict
	and shall specify its rating, type, and required circuit location		N/A
5.3.2.10	Remote indication of faults		P
	The installation instructions shall include an explanation of how to properly make connections to (where applicable), and use, the electrical or electronic fault indication required by 13.9.		P
5.3.2.11	External array insulation resistance measurement and response		N/A
	The installation instructions for an inverter for use with ungrounded arrays that does not incorporate all the aspects of the insulation resistance measurement and response requirements in 4.8.2.1, must include:		N/A
	- for isolated inverters: an explanation of what aspects of array insulation resistance measurement and response are not provided, and		N/A
	- an instruction to consult local regulations to determine if any additional functions are required or not;		N/A
	- for non-isolated inverters: an explanation of what external equipment must be provided in the system, and		N/A
	- what the setpoints and response implemented by that equipment must be, and:		N/A
	- how that equipment is to be interfaced with the rest of the system.		N/A
5.3.2.12	Array functional grounding information		N/A
	Where approach a) of 4.8.2.2 is used, the installation instructions for the inverter shall include all of the following:		N/A
	a) the value of the total resistance between the PV circuit and ground integral to the inverter		N/A
	b) the minimum array insulation resistance to ground that system designer or installer must meet when selecting the PV panel and system design, based on the minimum value that the design of the PV functional grounding in the inverter was based on		N/A
	c) the minimum value of the total resistance $R = V_{MAX} PV/30 \text{ mA}$ that the system must meet, with an explanation of how to calculate the total		N/A
	d) a warning that there is a risk of shock hazard if the total minimum resistance requirement is not met.		N/A
5.3.2.13	Stand-alone inverters for dedicated loads		N/A
	Where the approach of 4.7.5.5 is used, the installation instructions for the inverter shall include a warning that the inverter is only to be used with the dedicated load for which it was evaluated, and		N/A
	shall specify the dedicated load.		N/A
5.3.2.14	Identification of firmware version(s)		P
	An inverter utilizing firmware for any protective functions shall provide means to identify the firmware version.		P

IEC 62109-2			
Clause	Requirement + Test	Result - Remark	Verdict
	This can be a marking, but the information can also be provided by a display panel, communications port or any other type of user interface.....	By communication or display panel	P
7	PROTECTION AGAINST ELECTRIC SHOCK AND ENERGY HAZARDS		P
7.3	Protection against electric shock		P
7.3.10	Additional requirements for stand-alone inverters		N/A
	One circuit conductor bonded to earth to create a grounded conductor and an earthed system.	Grid-interactive inverter	N/A
	The means used to bond the grounded conductor to protective earth provided within the inverter or as part of the installation		N/A
	If not provided integral to the inverter, the required means shall be described in the installation instructions as per 5.3.2.8.		N/A
	The means used to bond the grounded conductor to protective earth shall comply with the requirements for protective bonding in Part 1,		N/A
	If the bond can only ever carry fault currents in stand-alone mode, the maximum current for the bond is determined by the inverter maximum output fault current.		N/A
	Output circuit bonding arrangements shall ensure that in any mode of operation, the system only has the grounded circuit conductor bonded to earth in one place at a time.		N/A
	Switching arrangements may be used, in which case the switching device used is to be subjected to the bond impedance test along with the rest of the bonding path		N/A
	Inverters intended to have a circuit conductor bonded to earth shall not impose any normal current on the bond except for leakage current.		N/A
	Outputs that are intentionally floating with no circuit conductor bonded to ground, must not have any voltages with respect to ground that are a shock hazard in accordance with Clause 7 of Parts 1 and 2.		N/A
	The documentation for the inverter shall indicate that the output is floating as per 5.3.2.8.		N/A
7.3.11	Functionally grounded arrays		N/A
	All PV conductors in a functionally grounded array shall be treated as being live parts with respect to protection against electric shock.		N/A
9	PROTECTION AGAINST FIRE HAZARDS		P
9.3	Short-circuit and overcurrent protection		P
9.3.4	Inverter backfeed current onto the array		P
	The backfeed current testing and documentation requirements in Part 1 apply, including but not limited to the following.		P
	Inverter backfeed current onto the PV array maximum value.....		P
	This inverter backfeed current value shall be provided in the installation instructions regardless of the value of the current, in accordance with Table 33.		P

IEC 62109-2			
Clause	Requirement + Test	Result - Remark	Verdict
13	PHYSICAL REQUIREMENTS		P
13.9	Fault indication		P
	Where this Part 2 requires the inverter to indicate a fault, both of the following shall be provided:		P
	a) a visible or audible indication, integral to the inverter, and detectable from outside the inverter, and		P
	b) an electrical or electronic indication that can be remotely accessed and used.		P
	The installation instructions shall include information regarding how to properly make connections (where applicable) and use the electrical or electronic means in b) above, in accordance with 5.3.2.10.		P

4.4.4	TABLE: Single fault condition to be applied						P
	Ambient temperature (°C)						—
	Power source for EUT: Manufacturer, model/type, output rating						—
4.4.4.15.1	Fault-tolerance of residual current monitoring						
Component No.	Fault	Supply voltage	Test time	Fuse #	Fuse current(A)	Observation	
GFCI check	R 869 Short Circuit	520Vdc/230Vac	3 min	-	-	Unit can't operate, error message: LeakCurrFault no danger, no hazard, no fire	
GFCI check	R 554 Open Circuit	520Vdc/230Vac	3 min	-	-	Unit can't operate, error message: LeakCurrFault no danger, no hazard, no fire	
Check that the residual current monitoring operates properly						Yes	
Supplementary information:							

4.4.4	TABLE: Single fault condition to be applied						P
	Ambient temperature (°C)						—
	Power source for EUT: Manufacturer, model/type, output rating						—
4.4.4.15.2	Fault-tolerance of automatic disconnecting means						
Component No.	Fault	Supply voltage (V)	Test time	Fuse #	Fuse current (A)	Observation	
Relay (ALFG2)	short circuit before starting up	PV:450V	10min	/	/	Unit can't operate, error message: Relay 1 Fault No danger, no hazard, no fires	
Relay (ALFG3)	short circuit before starting up	PV:450V	10min	/	/	Unit can't operate, error message: Relay 1 Fault No danger, no hazard, no fires	
Check that the relays fulfil the basic insulation or simple separation based on the PV circuit working voltage.						Yes	
Each active phase can be switched. (Land N)						Yes	
Supplementary information:							

4.4.4.17	Cooling system failure – Blanketing test		P
	Model	BNT006KTL	—
	Test voltage (Vdc)	620	—
	Test current (Idc)	10	—
	Test voltage (Vac).....	230	—
	Test current (Iac)	8.7	—
maximum temperature T of part/at:		T (°C)	T _{max} (°C)
1.	Ambient temp.	42	-
2.	Front enclosure	70	90
3.	Rear enclosure	74	90
4.	Left enclosure	67	90
5.	Right enclosure	74	90
6.	Bottom enclosure	70	90
7.	Top enclosure	75	90
8.	Mounting Surface	71	90
Supplementary information:			

4.4.4.17	Cooling system failure – Blanketing test		P
	Model	BNT012KTL	—
	Test voltage (Vdc)	620	—
	Test current (Idc)	20	—
	Test voltage (Vac).....	230	—
	Test current (Iac)	17.5	—
maximum temperature T of part/at:		T (°C)	T _{max} (°C)
1.	Ambient temp.	33	-
2.	Front enclosure	68	90
3.	Rear enclosure	72	90
4.	Left enclosure	66	90
5.	Right enclosure	73	90
6.	Bottom enclosure	72	90
7.	Top enclosure	61	90
8.	Mounting Surface	72	90
Supplementary information:			

4.4.4.17	Cooling system failure – Blanketing test		P
	Model	BNT025KTL	—
	Test voltage (Vdc)	700	—
	Test current (Idc)	35.7	—
	Test voltage (Vac).....	230	—
	Test current (Iac)	36.2	—
maximum temperature T of part/at:		T (°C)	T _{max} (°C)
1.	Ambient temp.	30	-
2.	Front enclosure	77	90
3.	Rear enclosure	76	90
4.	Left enclosure	76	90
5.	Right enclosure	73	90
6.	Bottom enclosure	73	90
7.	Top enclosure	73	90
8.	Mounting Surface	71	90
Supplementary information:			

4.7.4	TABLE: Steady state Inverter AC output voltage and frequency		N/A
	Nominal DC input (V)		
	Nominal output AC voltage (V) :		
AC output U (V)	Frequency (Hz)	Condition/status	Comments
		Without load	
		Resistive load application	
		Resistive load removal	
Supplementary information:			

4.8.2	TABLE: Array insulation resistance detection for inverters for ungrounded and functionally grounded arrays				P
4.8.2.1	Array insulation resistance detection for inverters for ungrounded arrays				
DC Voltage below minimum operating voltage (V)	DC Voltage for inverter begin operation (V)	Resistance between ground and PV input terminal (kΩ)	Required Insulation resistance $R = (V_{MAX PV} / 30mA)$ (kΩ)	Result	
DC+					
140	200	50	36.67	Fault information: Isolation Fault And repeat five times	
DC-					
140	200	50	36.67	Fault information: Isolation Fault And repeat five times	
<p>Note:</p> <p>For isolated inverters, shall indicate a fault in accordance with 13.9 (operation is allowed); the fault indication shall be maintained until the array insulation resistance has recovered to a value higher than the limit above</p> <p>For non-isolated inverters, or inverters with isolation not complying with the leakage current limits in the minimum inverter isolation requirements in Table 30, shall indicate a fault in accordance with 13.9, and shall not connect to the mains; the inverter may continue to make the measurement, may stop indicating a fault and may connect to the mains if the array insulation resistance has recovered to a value higher than the limit above.</p> <p>It is not required to test all PV input terminals if analysis of the design indicates that one or more terminals can be expected to have the same result, for example where multiple PV string inputs are in parallel.</p> <p>Supplementary information:</p> <p>All models have same setting, the Max power model tested for typical model.</p>					

4.8.3.2	TABLE: 30mA touch current type test for isolated inverters			N/A
Condition	Current (mA)		Limit (30mA)	
DC+ to PE	-		30mA	
DC- to PE	-		30mA	
<p>Supplementary information:</p> <p>The touch current measurement circuit of IEC 60990, Figure 4 is connected from each terminal of the array to ground, one at a time.</p>				

4.8.3.3	TABLE: Fire hazard residual current type test for isolated inverters			N/A
Condition	Current (mA)		Limit (300mA or 10mA per kVA)	
DC+ to PE	-		300mA	
DC- to PE	-		300mA	
<p>Supplementary information:</p>				

4.8.3.5	TABLE: Protection by residual current monitoring			P
Test conditions:		Output power (kVA): 20 Input voltage (V_{DC}): 650 Frequency (Hz):50Hz Output AC Voltage (V_{AC}):230V		
4.8.3.5.2	Test for detection of excessive continuous residual current			P
Fault Current (mA)		Disconnection time (ms)		
Measured Fault Current	Limit 300mA for output power ≤ 30 kVA 10mA per kVA for output power > 30 kVA	Measured Disconnection time	Limit	
+ PV to N:				
195mA	300mA	128 ms	300	
195mA	300mA	128 ms	300	
195mA	300mA	127 ms	300	
195mA	300mA	125 ms	300	
195mA	300mA	131 ms	300	
- PV to N:				
195mA	300mA	130 ms	300	
195mA	300mA	123 ms	300	
195mA	300mA	126 ms	300	
195mA	300mA	137 ms	300	
195mA	300mA	129 ms	300	
Note: – maximum 300mA for inverters with continuous output power rating ≤30 kVA; – maximum 10mA per kVA of rated continuous output power for inverters with continuous output power rating > 30 kVA. This test shall be repeated 5 times, and for all 5 tests the time to disconnect shall not exceed 0,3s. The test is repeated for each PV input terminal. It is not required to test all PV input terminals if analysis of the design indicates that one or more terminals can be expected to have the same result, for example where multiple PV string inputs are in parallel.				
Supplementary information: All models have same setting, the Max power model tested for typical model.				

4.8.3.5.3	TABLE: Test for detection of sudden changes in residual current		P
+PV to N			
Limit (mA)	U_N		Limit (ms)
	Disconnection time (ms)		
30	158		300
30	156		300
30	153		300
30	177		300
30	146		300
60	83		150
60	109		150
60	94		150
60	94		150
60	96		150
150	23		40
150	25		40
150	27		40
150	21		40
150	29		40
-PV to N			
Limit (mA)	U_N		Limit (ms)
	Disconnection time (ms)		
30	145		300
30	175		300
30	180		300
30	140		300
30	148		300
60	107		150
60	103		150
60	104		150
60	80		150
60	88		150
150	26		40
150	27		40
150	30		40
150	21		40
150	23		40
Note: The capacitive current is raised until disconnection. Test condition: $I_c + 30/60/150mA \leq I_{cmax}$. R_1 is set that 30/60/150mA Flow and switch S is closed.			
Supplementary information: All models have the same setting, the Max power model tested for typical model.			

End of Test Report