



TEST REPORT
Engineering Recommendation EN 50549-1:2019
Requirements for the connection of generation equipment in parallel with public distribution networks

Report Reference No.: 220900591SHA-001

Tested by (name + signature): Chuanhui Xie

Chuanhui Xie

Approved by (name + signature): Sleif Sui

Sleif Sui

Date of issue.....: 2022-09-23

Contents: 98 pages

Testing Laboratory: Intertek Testing Services Shanghai.

Address.....: Building No.86, 1198 Qinzhou Road (North), Shanghai 200233, China.

Testing location / address.....: Same as above

Applicant's name: Afore New Energy Technology (Shanghai)Co., Ltd.

Address.....: Build No.7, 333 Wanfang Road, Minhang District, Shanghai. China. 201112

Test specification:

Standard: EN 50549-1:2019 Requirements for the connection of generation equipment in parallel with public distribution networks.

Test procedure.....: testing

Non-standard test method.....: N/A

Test Report Form/blank test report

Test Report Form No.....: TTRF_ 50549-1

TRF Originator: Intertek Shanghai

Master TRF: 2019-11

This publication may be reproduced in whole or in part for non-commercial purpose as long as Intertek is acknowledged as copyright owner and source of the material. Intertek takes no responsibility and will not assume liability for damages resulting from the reader's interpretation of the reproduced material due to its placement and context.

This report is for the exclusive use of Intertek's Client and is provided pursuant to the agreement between Intertek and its Client. Intertek's responsibility and liability are limited to the terms and conditions of the agreement. Intertek assumes no liability to any party, other than to the Client in accordance with the agreement, for any loss, expense or damage occasioned by the use of this report. Only the Client is authorized to permit copying or distribution of this report and then only in its entirety. Any use of the Intertek name or one of its marks for the sale or advertisement of the tested material, product or service must first be approved in writing by Intertek. The observations and test results in this report are relevant only to the sample tested. This report by itself does not imply that the material, product, or service is or has ever been under an Intertek certification program.

Test item description	Hybrid Inverter
Trade Mark	Afore
Manufacturer	Same as applicant
Model/Type reference	AF1K-SL-1, AF1.5K-SL-1, AF2K-SL-1, AF2.5K-SL-1, AF3K-SL-1, AF3.6K-SL-1, AF3K-SL, AF3.6K-SL, AF4K-SL, AF4.6K-SL, AF5K-SL, AF5.5K-SL, AF6K-SL
Rating	See below Specifications table

Specifications table					
Model	AF1K-SL-1	AF1.5K-SL-1	AF2K-SL-1	AF2.5K-SL-1	AF3K-SL-1
Input					
Ppv Max (W)	1500	2300	3000	3800	4500
Vmax PV (V)	550	550	550	550	550
Isc PV (absolute Max.) (A)	26	26	26	26	26
Number of MPP trackers	1	1	1	1	1
Number of input strings	1	1	1	1	1
Max. PV input range (A)	18.5	18.5	18.5	18.5	18.5
MPPT Voltage Range (V)	80-500	80-500	80-500	80-500	80-500
Vdc range @ full power (V)	80-500	90-500	120-500	150-500	170-500
Battery (input and output)					
Battery type	Li-ion / lead acid etc.				
Battery Nominal Voltage (V)	51.2				
Battery Voltage Range (V)	40-60				
Max. Charge/Discharge Current (A)	25	40	50	63	80
Max. Charge/Discharge Power (W)	1000	1500	2000	2500	3000
AC Grid (input and output)					
Nominal Voltage (V)	L/N/PE. 230Vac				
Nominal Frequency (Hz)	50				
Max. continuous Input/output Current (A)	5	7	10	12	14
Nominal Power (W)	1000	1500	2000	2500	3000
Max. Power (W)	1000	1500	2000	2500	3000
Max. apparent Power (VA)	1000	1500	2000	2500	3000
Power Factor	1(-0.8~+0.8 adjustable)				
AC Load output					
Nominal Output Voltage (V)	L/N/PE. 230Vac				
Nominal Frequency (Hz)	50				
Max. continuous Input/output Current (A)	5	7	10	12	14
Nominal Output Power(W)	1000	1500	2000	2500	3000
Max. Output Power (W)	1000	1500	2000	2500	3000
Max. apparent Power (VA)	1000	1500	2000	2500	3000
Power Factor	1				
others					
Ingress protection (IP)	IP65				
Temperature (°C)	-25°C to +60°C (Derating45°C)				
Inverter Isolation	Non-isolated				
Firmware Version	V06				

Specifications table					
Model	AF3.6K-SL-1	AF3K-SL	AF3.6K-SL	AF4K-SL	AF4.6K-SL
Input					
Ppv Max (W)	5400	4500	5400	6000	6900
Vmax PV (V)	550	550	550	550	550
Isc PV (absolute Max.) (A)	26	26 x 2	26 x 2	26 x 2	26 x 2
Number of MPP trackers	1	2	2	2	2
Number of input strings	1	1/1	1/1	1/1	1/1
Max. PV input range (A)	18.5	18.5 x 2	18.5 x 2	18.5 x 2	18.5 x 2
MPPT Voltage Range (V)	80-500	80-500	80-500	80-500	80-500
Vdc range @ full power (V)	210-500	90-500	110-500	120-500	130-500
Battery (input and output)					
Battery type	Li-ion / lead acid etc.				
Battery Nominal Voltage (V)	51.2				
Battery Voltage Range (V)	40-60				
Max. Charge/Discharge Current (A)	80	80	80	80	80
Max. Charge/Discharge Power (W)	3600	3000	3600	4000	4600
AC Grid (input and output)					
Nominal Voltage (V)	L/N/PE. 230Vac				
Nominal Frequency (Hz)	50				
Max. continuous Input/output Current (A)	17	14	17	19	22
Nominal Power (W)	3600	3000	3600	4000	4600
Max. Power (W)	3600	3000	3600	4000	4600
Max. apparent Power (VA)	3600	3000	3600	4000	4600
Power Factor	1(-0.8~+0.8 adjustable)				
AC Load output					
Nominal Output Voltage (V)	L/N/PE. 230Vac				
Nominal Frequency (Hz)	50				
Max. continuous Input/output Current (A)	17	14	17	19	22
Nominal Output Power(W)	3600	3000	3600	4000	4600
Max. Output Power (W)	3600	3000	3600	4000	4600
Max. apparent Power (VA)	3600	3000	3600	4000	4600
Power Factor	1				
others					
Ingress protection (IP)	IP65				
Temperature (°C)	-25°C to +60°C (Derating45°C)				
Inverter Isolation	Non-isolated				
Firmware Version	V06				

Specifications table					
Model	AF5K-SL	AF5.5K-SL	AF6K-SL		
Input					
Ppv Max (W)	7500	8300	9000		
Vmax PV (V)	550	550	550		
Isc PV (absolute Max.) (A)	26 x 2	26 x 2	26 x 2		
Number of MPP trackers	2	2	2		
Number of input strings	1/1	1/1	1/1		
Max. PV input range (A)	18.5 x 2	18.5 x 2	18.5 x 2		
MPPT Voltage Range (V)	80-500	80-500	80-500		
Vdc range @ full power (V)	150-500	160-500	170-500		
Battery (input and output)					
Battery type	Li-ion / lead acid etc.				
Battery Nominal Voltage (V)	51.2				
Battery Voltage Range (V)	40-60				
Max. Charge/Discharge Current (A)	80	80	80		
Max. Charge/Discharge Power (W)	4800	4800	4800		
AC Grid (input and output)					
Nominal Voltage (V)	L/N/PE. 230Vac				
Nominal Frequency (Hz)	50				
Max. continuous Input/output Current (A)	23	26	28		
Nominal Power (W)	5000	5500	6000		
Max. Power (W)	5000	5500	6000		
Max. apparent Power (VA)	5000	5500	6000		
Power Factor	1(-0.8~+0.8 adjustable)				
AC Load output					
Nominal Output Voltage (V)	L/N/PE. 230Vac				
Nominal Frequency (Hz)	50				
Max. continuous Input/output Current (A)	23	26	28		
Nominal Output Power(W)	5000	5500	6000		
Max. Output Power (W)	5000	5500	6000		
Max. apparent Power (VA)	5000	5500	6000		
Power Factor	1				
others					
Ingress protection (IP)	IP65				
Temperature (°C)	-25°C to +60°C (Derating45°C)				
Inverter Isolation	Non-isolated				
Firmware Version	V06				

Summary of testing:																																									
<p>Tests performed (name of test and test clause):</p> <table border="1"> <thead> <tr> <th>EN 50549-1</th> <th>Test Description</th> </tr> </thead> <tbody> <tr><td>4.4.2</td><td>Operating frequency range</td></tr> <tr><td>4.4.3</td><td>Minimal requirements for active power delivery at underfrequency</td></tr> <tr><td>4.4.4</td><td>Continuous voltage operation range</td></tr> <tr><td>4.5.2</td><td>Rate of change of frequency (ROCOF)</td></tr> <tr><td>4.5.3</td><td>UVRT</td></tr> <tr><td>4.5.4</td><td>OVRT</td></tr> <tr><td>4.6.1</td><td>Power response to over frequency</td></tr> <tr><td>4.6.2</td><td>Power response to underfrequency</td></tr> <tr><td>4.7.2.2</td><td>Q Capabilities (Power Factor) & Q(U) Capabilities</td></tr> <tr><td>4.7.2.3.3</td><td>Q Control. Voltage related control mode</td></tr> <tr><td>4.7.2.3.4</td><td>Q Control Power related control modes</td></tr> <tr><td>4.7.3</td><td>Voltage control by active power</td></tr> <tr><td>4.7.4</td><td>Zero current mode</td></tr> <tr><td>4.9.3</td><td>Interface protection</td></tr> <tr><td>4.9.4.</td><td>Islanding</td></tr> <tr><td>4.10.2</td><td>Reconnection after tripping</td></tr> <tr><td>4.10.3</td><td>Starting to generate electrical power</td></tr> <tr><td>4.11</td><td>Active power reduction by setpoint and ceasing active power (Logic interface)</td></tr> <tr><td>4.13</td><td>Single fault tolerance of interface protection and interface switch</td></tr> </tbody> </table> <p>Remark: Other than special notice, the model AF6k-SL is type tested and valid for other models.</p>	EN 50549-1	Test Description	4.4.2	Operating frequency range	4.4.3	Minimal requirements for active power delivery at underfrequency	4.4.4	Continuous voltage operation range	4.5.2	Rate of change of frequency (ROCOF)	4.5.3	UVRT	4.5.4	OVRT	4.6.1	Power response to over frequency	4.6.2	Power response to underfrequency	4.7.2.2	Q Capabilities (Power Factor) & Q(U) Capabilities	4.7.2.3.3	Q Control. Voltage related control mode	4.7.2.3.4	Q Control Power related control modes	4.7.3	Voltage control by active power	4.7.4	Zero current mode	4.9.3	Interface protection	4.9.4.	Islanding	4.10.2	Reconnection after tripping	4.10.3	Starting to generate electrical power	4.11	Active power reduction by setpoint and ceasing active power (Logic interface)	4.13	Single fault tolerance of interface protection and interface switch	<p>Testing location: Building No.86, 1198 Qinzhou Road (North), Shanghai 200233, China</p>
EN 50549-1	Test Description																																								
4.4.2	Operating frequency range																																								
4.4.3	Minimal requirements for active power delivery at underfrequency																																								
4.4.4	Continuous voltage operation range																																								
4.5.2	Rate of change of frequency (ROCOF)																																								
4.5.3	UVRT																																								
4.5.4	OVRT																																								
4.6.1	Power response to over frequency																																								
4.6.2	Power response to underfrequency																																								
4.7.2.2	Q Capabilities (Power Factor) & Q(U) Capabilities																																								
4.7.2.3.3	Q Control. Voltage related control mode																																								
4.7.2.3.4	Q Control Power related control modes																																								
4.7.3	Voltage control by active power																																								
4.7.4	Zero current mode																																								
4.9.3	Interface protection																																								
4.9.4.	Islanding																																								
4.10.2	Reconnection after tripping																																								
4.10.3	Starting to generate electrical power																																								
4.11	Active power reduction by setpoint and ceasing active power (Logic interface)																																								
4.13	Single fault tolerance of interface protection and interface switch																																								

<p>Test item particulars..... :</p> <p>Temperature range : -25°C ~60°C (Derating 45 °C)</p> <p>IP protection class : IP 65</p>
<p>Possible test case verdicts:</p> <p>- test case does not apply to the test object..... : N/A</p> <p>- test object does meet the requirement : P(Pass)</p> <p>- test object does not meet the requirement : F(Fail)</p>
<p>Testing..... :</p> <p>Date of receipt of test item..... : 2022-09-08</p> <p>Date (s) of performance of tests..... : 2022-09-09 to 2022-09-20</p>
<p>General remarks:</p> <p>The test results presented in this report are only to the object (single power inverter unit) tested and base on Low Voltage connected on small power station.</p> <p>Installer and relevant persons shall comply with EN 50549-1:2019, Local code and Grid Code in EN 50549-1:2019.</p> <p>This report shall not be reproduced, except in full, without the written approval of the Issuing testing laboratory.</p> <p>"(see Enclosure #)" refers to additional information appended to the report.</p> <p>"(see appended table)" refers to a table appended to the report.</p> <p>Throughout this report a point is used as the decimal separator.</p> <p>Determination of the test conclusion is based on IEC Guide 115 in consideration of measurement uncertainty.</p> <p>Determination of the test result includes consideration of measurement uncertainty from the test equipment and methods.</p> <p>The test results presented in this report relate only to the item tested. The results indicate that the specimen partially complies with standard" EN 50549-1:2019". See general product information next for details information.</p>

General product information:

The testing item is a single-phase hybrid type inverter for indoor or outdoor installation.

The relays are designed to redundant structure that controlled by separately.

The master controller and slave controller are used together to control relay open or close, if the single fault on one controller, the other controller can be capable to open the relay, so that still providing safety means.

The topology diagram as following:

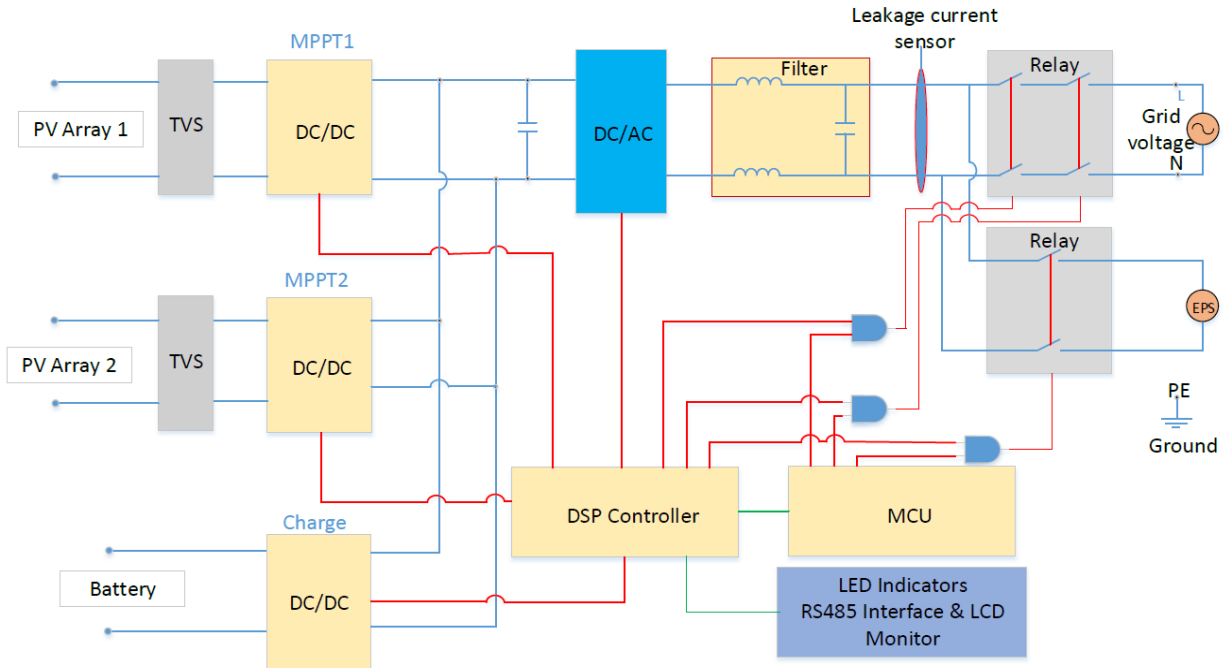

Model differences:

All models are identical with hardware version and software version, the output power is derating by software.

Model AF1K-SL-1, AF1.5K-SL-1, AF2K-SL-1, AF2.5K-SL-1, AF3K-SL-1, AF3.6K-SL-1 has 1 MPPT tracker with 1 input string, and model AF3K-SL, AF3.6K-SL, AF4K-SL, AF4.6K-SL, AF5K-SL, AF5.5K-SL, AF6K-SL has 2 MPPT trackers and every MPPT tracker has 1 input string.

Factory information:

Afore New Energy Technology (Shanghai) Co., Ltd.

Build No.7, 333 Wanfang Road, Minhang District, Shanghai. China. 201112

Copy of marking plate

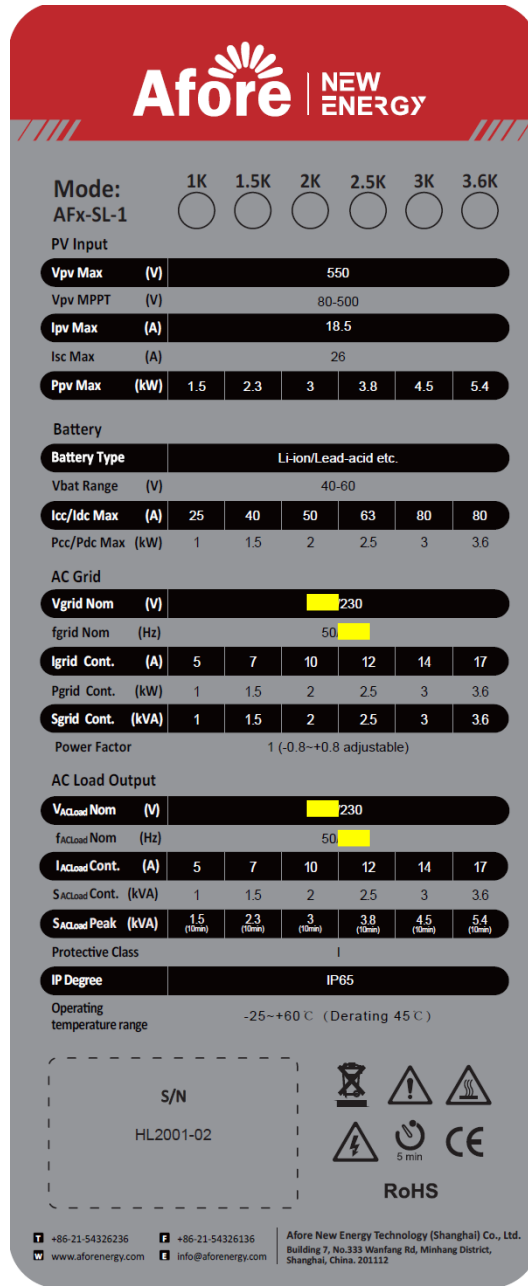

Note:

1. The above markings are the minimum requirements required by the safety standard. For the final production samples, the additional markings which do not give rise to misunderstanding may be added.
2. Label is attached on the side surface of enclosure and visible after installation
3. Other marking plate are identical to above, except the model's name and ratings
4. The information covered by [redacted] on marking plate was irrelevant to this report.
5. The model name: AFxSL-1, x means 1K, 1.5K, 2K, 2.5K, 3K, 3.6K
The model name: AFx-SL, x means 3K, 3.6K, 4K, 5K, 5.5K, 6K

EN 50549-1:2019			
Clause	Requirement - Test	Result - Remark	Verdict
4	Requirements on generating plants		P
4.1	General	This report is only evaluated and tested for generating unit; The generating plant incorporated with the generating unit shall further consider this clause and sub-clause.	N/A
4.2	Connection scheme	Shall consider in final PGS	N/A
4.3	Choice of switchgear		P
4.3.1	General Switches shall be chosen based on the characteristics of the power system in which they are intended to be installed. For this purpose, the short circuit current at the installation point shall be assessed, taking into account, inter alia, the short circuit current contribution of the generating plant.		P
4.3.2	Interface switch Switches shall be power relays, contactors or mechanical circuit breakers each having a breaking and making capacity corresponding to the rated current of the generating plant and corresponding to the short circuit contribution of the generating plant. The short- time withstand current of the switching devices shall be coordinated with rated short circuit power at the point of connection. In case of loss of auxiliary supply power to the switchgear, a secure disconnection of the switch is required immediately. Where means of isolation (according to HD 60364-5-551) is not required to be accessible to the DSO at all times, automatic disconnection with single fault tolerance according to 4.13 shall be provided. The function of the interface switch might be combined with either the main switch or the generating unit switch in a single switching device. In case of a combination, the single switching device shall be compliant to the requirements of both, the interface switch and the combined main switch or generating unit switch. As a consequence, at least two switches in series shall be present between any generating unit and the POC.	The interface switch is constructed of redundancy, made up of two series relays and power and control separately. The EUT is a PV inverter, further evaluation refers to EN 62109-1 and EN 62109-2 with respect to the interface switch.	P
4.4	Normal operating range		P
4.4.1	General Generating plants when generating power shall have the capability to operate in the operating ranges specified below regardless of the topology and the settings of the interface protection.		P

EN 50549-1:2019			
Clause	Requirement - Test	Result - Remark	Verdict
4.4.2	<p>Operating frequency range The generating plant shall be capable of operating continuously when the frequency at the point of connection stays within the range of 49 Hz to 51 Hz. In the frequency range from 47 Hz to 52 Hz the generating plant should be capable of operating until the interface protection trips. Therefore, the generating plant shall at least be capable of operating in the frequency ranges, for the duration and for the minimum requirement as indicated in Table 1. Respecting the legal framework, it is possible that for some synchronous areas more stringent time periods and/or frequency ranges will be required by the DSO and the responsible party. Nevertheless, they are expected to be within the boundaries of the stringent requirement as indicated in Table 1 unless producer, DSO, TSO and responsible party agree on wider frequency ranges and longer durations.</p>	See appended table 4.4.2	P
4.4.3	<p>Minimal requirement for active power delivery at underfrequency A generating plant shall be resilient to the reduction of frequency at the point of connection while reducing the maximum active power as little as possible. The admissible active power reduction due to underfrequency is limited by the full line in Figure 5 and is characterized by a maximum allowed reduction rate of 10 % of P_{max} per 1 Hz for frequencies below 49,5 Hz. It is possible that a more stringent power reduction characteristic is required by the responsible party. Nevertheless this requirement is expected to be limited to an admissible active power reduction represented by the dotted line in Figure 5 which is characterised by a reduction rate of 2 % of the maximum power P_{max} per 1 Hz for frequencies below 49 Hz. If any technologies intrinsic design or ambient conditions have influence on the power reduction behaviour of the system, the manufacturer shall specify at which ambient conditions the requirements can be fulfilled and eventual limitations. The information can be provided in the format of a graph showing the intrinsic behaviour of the generating unit for example at different ambient conditions. The power reduction and the ambient conditions shall comply with the specification given by the responsible party. If the generating unit does not meet the power reduction at the specified ambient conditions, the producer and the responsible party shall agree on acceptable ambient conditions.</p>	See appended table 4.4.3	P

EN 50549-1:2019			
Clause	Requirement - Test	Result - Remark	Verdict
4.4.4	<p>Continuous operating voltage range When generating power, the generating plant shall be capable of operating continuously when the voltage at the point of connection stays within the range of 85 % U_n to 110 % U_n. Beyond these values the under and over voltage ride through immunity limits as specified in clause 4.5.3 and 4.5.4 shall apply. In case of voltages below U_n, it is allowed to reduce the apparent power to maintain the current limits of the generating plant. The reduction shall be as small as technically feasible. For this requirement all phase to phase voltages and in case a neutral is connected, additionally all phase to neutral voltages shall be evaluated.</p>	See appended table 4.4.4	P
4.5	Immunity to disturbances		P
4.5.1	<p>General In general, generating plants should contribute to overall power system stability by providing immunity towards dynamic voltage changes unless safety standards require a disconnection. The following clauses describe the required immunity for generating plants taking into account the connection technology of the generating modules. The following withstand capabilities shall be provided regardless of the settings of the interface protection.</p>		P
4.5.2	<p>Rate of change of frequency (ROCOF) immunity ROCOF immunity of a power generating plant means that the generating modules in this plant stay connected with the distribution network and are able to operate when the frequency on the distribution network changes with a specified ROCOF. The generating units and all elements in the generating plant that might cause their disconnection or impact their behaviour shall have this same level of immunity. The generating modules in a generating plant shall have ROCOF immunity for a ROCOF equal or exceeding the value specified by the responsible party. If no ROCOF immunity value is specified, the following ROCOF immunity shall apply, making distinction between generating technologies: • Non-synchronous generating technology: at least 2 Hz/s • Synchronous generating technology: at least 1 Hz/s</p>	See appended table 4.5.2	P
4.5.3	Under-voltage ride through (UVRT)		P
4.5.3.1	<p>General Generating modules classified as type B modules according to COMMISSION REGULATION 2016/631 shall comply with the requirements of 4.5.3.2 and 4.5.3.3. Generating modules classified as type A and smaller according to COMMISSION REGULATION 2016/631 should comply with these requirements. The actual behaviour of type A modules and smaller shall be specified in the connection agreement. The requirements apply to all kinds of faults (1ph, 2ph and 3ph).</p>		P

EN 50549-1:2019			
Clause	Requirement - Test	Result - Remark	Verdict
4.5.3.2	<p>Generating plant with non-synchronous generating technology</p> <p>Generating modules shall be capable of remaining connected to the distribution network as long as the voltage at the point of connection remains above the voltage-time curve of Figure 6. The voltage is relative to U_n. The smallest phase to neutral voltage, or if no neutral is present, the smallest phase to phase voltage shall be evaluated. The responsible party may define a different UVRT characteristic. Nevertheless, this requirement is expected to be limited to the most stringent curve as indicated in Figure 6. This means that the whole generating module has to comply with the UVRT requirement. This includes all elements in a generating plant: the generating units and all elements that might cause their disconnection.</p> <p>For the generating unit, this requirement is considered to be fulfilled if it stays connected to the distribution grid as long as the voltage at its terminals remains above the defined voltage-time diagram.</p> <p>After the voltage returns to continuous operating voltage range, 90 % of pre-fault power or available power whichever is the smallest shall be resumed as fast as possible, but at the latest within 1 s unless the DSO and the responsible party requires another value.</p>	See appended table 4.5.3	P
4.5.3.3	<p>Generating plant with synchronous generating technology</p>		N/A
4.5.4	<p>Over-voltage ride through (OVRT)</p> <p>Generating modules, except for micro-generating plants, shall be capable of staying connected to the distribution network as long as the voltage at the point of connection remains below the voltage-time curve of Figure 8. The highest phase to neutral voltage or if no neutral is present the highest phase to phase voltage shall be evaluated.</p> <p>This means that not only the generating units shall comply with this OVRT requirement but also all elements in a generating plant that might cause its disconnection.</p>	See appended table 4.5.4	P
4.6	<p>Active response to frequency deviation</p>		P

EN 50549-1:2019			
Clause	Requirement - Test	Result - Remark	Verdict
4.6.1	<p>Power response to overfrequency Generating plants shall be capable of activating active power response to overfrequency at a programmable frequency threshold f_1 at least between and including 50,2 Hz and 52 Hz with a programmable droop in a range of at least $s=2\%$ to $s=12\%$. The droop reference is P_{ref}. Unless defined differently by the responsible party: • $P_{ref}=P_{max}$, in the case of synchronous generating technology and electrical energy storage systems. • $P_{ref}=P_M$, the actual AC output power at the instant when the frequency reaches the threshold f_1, in the case of all other non-synchronous generating technology The power value calculated according to the droop is a maximum power limit. If e.g. the available primary power decreases during a high frequency period below the power defined by the droop function, lower power values are permitted. The generating plant shall be capable of activating active power response to overfrequency as fast as technically feasible with an intrinsic dead time that shall be as short as possible with a maximum of 2 s and with a step response time of maximum 30 s, unless another value is defined by the relevant party. An intentional delay shall be programmable to adjust the dead time to a value between the intrinsic dead time and 2 s. After activation, the active power frequency response shall use the actual frequency at any time, reacting to any frequency increase or decrease according to the programmed droop with an accuracy of $\pm 10\%$ of the nominal power (see Figure 9). The resolution of the frequency measurement shall be ± 10 mHz or less. The accuracy is evaluated with a 1 min average value. At POC, loads if present in the producer's network might interfere with the response of the generating plant. The effect of loads is not considered for the evaluation of the accuracy, only the behaviour of the generating plant is relevant.</p>	See appended table 4.6.1	P
	<p>Generating plants reaching their minimum regulating level shall, in the event of further frequency increase, maintain this power level constant unless the DSO and the responsible party requires to disconnect the complete plant or if the plant consists of multiple units by disconnecting individual units. The active power frequency response is only deactivated if the frequency falls below the frequency threshold f_1. If required by the DSO and the responsible party an additional deactivation threshold frequency f_{stop} shall be programmable in the range of at least 50 Hz to f_1. If f_{stop} is configured to a frequency below f_1 there shall be no response according to the droop in case of a frequency decrease (see Figure 10). The output power is kept constant until the frequency falls below f_{stop} for a configurable time t_{stop}.</p>		P

EN 50549-1:2019			
Clause	Requirement - Test	Result - Remark	Verdict
	If at the time of deactivation of the active power frequency response the momentary active power P_M is below the available active power P_A , the active power increase of the generating plant shall not exceed the gradient defined in 4.10.2. Settings for the threshold frequency f_1 , the droop and the intentional delay are provided by the DSO and the responsible party. If no settings are provided, the default settings in Table 2 should be applied.		P
	The enabling and disabling of the function and its settings shall be field adjustable and means shall be provided to protect these from unpermitted interference (e.g. password or seal) if required by the DSO and the responsible party.		P
	Alternatively for the droop function described above, the following procedure is allowed for generating modules if permitted by the DSO and the responsible party: <ul style="list-style-type: none"> • the generating units shall disconnect at randomized frequencies, ideally uniformly distributed between the frequency threshold f_1 and 52 Hz; • in case the frequency decreases again, the generating unit shall start its reconnection procedure once the frequency falls below the specific frequency that initiated the disconnection; for this procedure, the connection conditions described in 4.10 do not apply; • the randomization shall either be at unit level by changing the threshold over time, or on plant level by choosing different values for each unit within a plant, or on distribution system level if the DSO specifies a specific threshold for each plant or unit connected to its distribution system. 		P
	EES units that are in charging mode at the time the frequency passes the threshold f_1 shall not reduce the charging power below P_M until frequency returns below f_1 . Storage units should increase the charging power according to the configured droop. In case the maximum charging capacity is reached or to prevent any other risk of injury or damage of equipment, a reduction of charging power is permitted.		Pass
4.6.2	Power response to underfrequency EES units shall be capable of activating active power response to underfrequency. Other generating units/plants should be capable of activating active power response to underfrequency. If active power to underfrequency is provided by a generating plant/unit, the function shall comply with the requirements below. Active power response to underfrequency shall be provided when all of the following conditions are met: <ul style="list-style-type: none"> • when generating, the generating unit is operating at active power below its maximum active power P_{max}; • when generating, the generating unit is operating at active power below the available active power P_A; • the voltages at the point of connection of the generating plant are within the continuous operating voltage range; • when generating, the generating unit is operating with currents lower than its current limit. In the case of EES units, active power frequency response to underfrequency shall be provided in charging and generating mode.	See appended table 4.6.2	P

EN 50549-1:2019			
Clause	Requirement - Test	Result - Remark	Verdict
	<p>The active power response to underfrequency shall be delivered at a programmable frequency threshold f_1 at least between and including 49,8 Hz and 46,0 Hz with a programmable droop in a range of at least 2 % to 12 %. The droop reference P_{ref} is P_{max}. If the available primary power or a local set value increases during an underfrequency period above the power defined by the droop function, higher power values are permitted. The power value calculated according to the droop is therefore a minimum limit.</p> <p>The generating unit shall be capable of activating active power response to underfrequency as fast as technically feasible with an intrinsic dead time that shall be as short as possible with a maximum of 2 s and with a step response time of maximum 30 s unless another value is defined by the relevant party.</p> <p>An intentional initial delay shall be programmable to adjust the dead time to a value between the intrinsic dead time and 2 s.</p>		P
	<p>After activation, the active power frequency response shall use the actual frequency at any time, reacting to any frequency increase or decrease according to the programmed droop with an accuracy of $\pm 10\%$ of the nominal power. The accuracy is evaluated with a 1 min average value. The resolution of the frequency measurement shall be ± 10 mHz or less. At POC loads, if present in the producer's network, might interfere with the response of the generating plant. The effect of loads is not considered for the evaluation of the accuracy, only the behaviour of the generating plant is relevant.</p>		P
	<p>Generating modules reaching any of the conditions above during the provision of active power frequency response shall, in the event of further frequency decrease, maintain this power level constant.</p> <p>The active power frequency response is only deactivated if the frequency increases above the frequency threshold f_1.</p>		P
	<p>Settings for the threshold frequency f_1, the droop and the intentional delay are defined by the DSO and the responsible party, if no settings are provided, the function shall be disabled.</p>		P
	<p>The activation and deactivation of the function and its settings shall be field adjustable and means shall be provided to protect these from unpermitted interference (e.g. password or seal) if required by the DSO and the responsible party.</p>		P
4.7	Power response to voltage changes		P
4.7.1	<p>General</p> <p>When the contribution to voltage support is required by the DSO and the responsible party, the generating plant shall be designed to have the capability of managing reactive and/or active power generation according to the requirements of this clause.</p>		P
4.7.2	Voltage support by reactive power		P

EN 50549-1:2019			
Clause	Requirement - Test	Result - Remark	Verdict
4.7.2.1	<p>General Generating plants shall not lead to voltage changes out of acceptable limits. These limits should be defined by national regulation. Generating units and plants shall be able to contribute to meet this requirement during normal network operation. Throughout the continuous operating frequency (see 4.4.2) and voltage (see 4.4.4) range, the generating plant shall be capable to deliver the requirements stipulated below. Outside these ranges, the generating plant shall follow the requirements as good as technically feasible although there is no specified accuracy required.</p>		P
4.7.2.2	<p>Capabilities Unless specified differently below, for specific generating technologies, generating plants shall be able to operate with active factors as defined by the DSO and the responsible party from active factor = 0,90_{underexcited} to active factor=0,90_{overexcited} The reactive power capability shall be evaluated at the terminals of the/each generating unit</p>		P
	<p>CHP generating units with a capacity ≤ 150 kVA shall be able to operate with active factors as defined by the DSO from $\cos \varphi = 0,95_{\text{underexcited}}$ to $\cos \varphi = 0,95_{\text{overexcited}}$ Generating units with an induction generator coupled directly to the grid and used in generating plants above micro generating level, shall be able to operate with active factors as defined by the DSO from $\cos \varphi = 0,95_{\text{underexcited}}$ to $\cos \varphi = 1$ at the terminals of the unit. Deviating from 4.7.2.3 only the $\cos \varphi$ set point mode is required. Deviating from the accuracy requirements below, the accuracy is only required at active power PD.</p>		N/A
	<p>Generating units with an induction generator coupled directly to the grid and used in micro generating plants shall operate with an active factor above 0,95 at the terminals of the generating unit. A controlled voltage support by reactive power is not required from this technology.</p>		N/A
	<p>Generating units with linear generators, coupled directly and synchronously to the grid shall operate with an active factor above 0,95 at the terminals of the generating unit, and therefore a controlled voltage support by reactive power is not required from this technology.</p>		N/A
	<p>In case of different generating technologies with different requirements in one generating plant, each unit shall provide voltage support by reactive power as required for its specific technology. A compensation of one technology to reach the general plant requirement is not expected. The DSO and the responsible party may relax the above requirements. This relaxation might be general or specific for a certain generating plant or generating technology.</p>		N/A

EN 50549-1:2019			
Clause	Requirement - Test	Result - Remark	Verdict
	<p>All involved parties can expect to have access to information documenting the actual choices regarding active power capabilities relative to reactive power requirements and related to the power rating in the operating voltage range (see further in this clause). A P-Q Diagram shall be included in the product documentation of a generating unit.</p> <p>When operating above the apparent power threshold S_{min} equal to 10 % of the maximum apparent power S_{max} or the minimum regulating level of the generating plant, whichever is the higher value, the reactive power capability shall be provided with an accuracy of $\pm 2\%$ S_{max}. Up to this apparent power threshold S_{min}, deviations above 2 % are permissible; nevertheless the accuracy shall always be as good as technically feasible and the exchange of uncontrolled reactive power in this low-power operation mode shall not exceed 10 % of the maximum apparent power S_{max}. At POC loads, if present in the producer's network might interfere with the response of the generating plant. The effect of loads is not considered for the evaluation of the accuracy, only the behaviour of the generating plant is relevant.</p> <p>For generating units with a reactive power capability according Figure 12 the reactive power capability at active power P_D shall be at least according Figure 13. For generating units with a reduced reactive power capability Figure 13 is only applicable up to the maximum reactive power capability.</p>		P
4.7.2.3	Control modes		P
4.7.2.3.1	<p>General</p> <p>Where required, the form of the contribution to voltage control shall be specified by the DSO.</p> <p>The control shall refer to the terminals of the generating units</p> <p>The generating plant/unit shall be capable of operating in the control modes specified below within the limits specified in 4.7.2.2. The control modes are exclusive; only one mode may be active at a time.</p> <ul style="list-style-type: none"> • Q setpoint mode • Q (U) • Cos ϕ setpoint mode • Cos ϕ (P) <p>For mass market products, it is recommended to implement all control modes. In case of site specific generating plant design, only the control modes required by the DSO need to be implemented.</p> <p>The configuration, activation and deactivation of the control modes shall be field adjustable. For field adjustable configurations and activation of the active control mode, means shall be provided to protect the settings from unpermitted interference (e.g. password or seal) if required by the DSO. Which control modes are available in a product and how they are configured shall be stated in the product documentation.</p>		P
4.7.2.3.2	<p>Setpoint control modes</p> <p>Q setpoint mode and cos ϕ setpoint mode control the reactive power output and the cos ϕ of the output respectively, according to a set point set in the control of the generating plant/unit.</p> <p>In the case of change of the set point local or by remote control the settling time for the new set point shall be less than one minute.</p>	See appended table 4.7.2	P

EN 50549-1:2019			
Clause	Requirement - Test	Result - Remark	Verdict
4.7.2.3.3	<p>Voltage related control mode The voltage related control mode Q (U) controls the reactive power output as a function of the voltage. There is no preferred state of the art for evaluating the voltage. Therefore it is the responsibility of the generating plant designer to choose a method. One of the following methods should be used:</p> <ul style="list-style-type: none"> • the positive sequence component of the fundamental. • the average of the voltages measured independently for each phase to neutral or phase to phase. • phase independently the voltage of every phase to determine the reactive power for every phase. 	Method 2 used	p
	<p>For voltage related control modes, a characteristic with a minimum and maximum value and three connected lines according to Figure 16 shall be configurable. In addition to the characteristic, further parameters shall be configurable:</p> <ul style="list-style-type: none"> • The dynamics of the control shall correspond with a first order filter having a time constant that is configurable in the range of 3 s to 60 s. 	See appended table 4.7.2	P
	<p>To limit the reactive power at low active power two methods shall be configurable:</p> <ul style="list-style-type: none"> • a minimal $\cos \varphi$ shall be configurable in the range of 0-0,95; • two active power levels shall be configurable both at least in the range of 0 % to 100 % of P_D. The lock-in value turns the Q(U) mode on, the lock-out value turns Q(U) off. If lock-in is larger than lock-out a hysteresis is given. See also Figure 14. The static accuracy shall be in accordance with 4.7.2.2. The dynamic accuracy shall be in accordance with Figure 15 with a maximum tolerance of +/- 5% of P_D plus a time delay of up to 3 seconds deviating from an ideal first order filter response. 		P
4.7.2.3.4	<p>Power related control mode The power related control mode $\cos \varphi$ (P) controls the $\cos \varphi$ of the output as a function of the active power output. For power related control modes, a characteristic with a minimum and maximum value and three connected lines shall be configurable in accordance with Figure 16. Resulting from a change in active power output a new $\cos \varphi$ set point is defined according to the set characteristic. The response to a new $\cos \varphi$ set value shall be as fast as technically feasible to allow the change in reactive power to be in synchrony with the change in active power. The new reactive power set value shall be reached at the latest within 10 s after the end value of the active power is reached. The static accuracy of each $\cos \varphi$ set point shall be according to 4.7.2.2.</p>	See appended table 4.7.2	P

EN 50549-1:2019			
Clause	Requirement - Test	Result - Remark	Verdict
4.7.3	<p>Voltage related active power reduction In order to avoid disconnection due to overvoltage protection (see 4.9.2.3 and 4.9.2.4), generating plants/units are allowed to reduce active power output as a function of this rising voltage. The final implemented logic can be chosen by the manufacturer. Nevertheless, this logic shall not cause steps or oscillations in the output power. The power reduction caused by such a function may not be faster than an equivalent of a time constant $\tau = 3 \text{ s}$ (= 33%/s at a 100% change). The enabling and disabling of the function shall be field adjustable and means have to be provided to protect the setting from unpermitted interference (e.g. password or seal) if required by the DSO.</p>	See appended table 4.7.3	P
4.7.4	Short circuit current requirements on generating plants		P
4.7.4.1	<p>General The following clauses describe the required short circuit current contribution for generating plants taking into account the connection technology of the generating modules. Generating modules classified as type B modules according to COMMISSION REGULATION 2016/631 shall comply with the requirements of 4.7.4.2 and 4.7.4.3. Generating modules classified as type A according to COMMISSION REGULATION 2016/631 should comply with these requirements. The actual behaviour of type A modules shall be specified in the connection agreement.</p>		P

EN 50549-1:2019			
Clause	Requirement - Test	Result - Remark	Verdict
4.7.4.2	Generating plant with non-synchronous generating technology		P
4.7.4.2.1	Voltage support during faults and voltage steps In general no voltage support during faults and voltage steps is required from generating plants connected in LV distribution networks as the additional reactive current is expected to interfere with grid protection equipment. If the responsible party requires voltage support during faults and voltage steps for generating plants of type B connected to LV distribution grids, the clause 4.7.4 of EN 50549-2 applies.	Only EN 50549-1 applies, if required by the responsible party for additional reactive current, the EN 50549-2 shall be applied	P
4.7.4.2.2	Zero current mode for converter connected generating technology If UVRT capability (see 4.5.3) is provided additional to the requirements of 4.5, generating units connected to the grid by a converter shall have the capability to reduce their current as fast as technically feasible down to or below 10 % of the rated current when the voltage is outside of a static voltage range. Generating units based on a doubly fed induction machine can only reduce the positive sequence current below 10 % of the rated current. Negative sequence current shall be tolerated during unbalanced faults. In case this current reduction is not sufficient, the DSO should choose suitable interface protection settings. The static voltage range shall be adjustable from 20 % to 100 % of U_n for the undervoltage boundary and from 100 % to 130 % of U_n for the overvoltage boundary. The default setting shall be 50% of U_n for the undervoltage boundary and 120% of U_n for the overvoltage boundary. Each phase to neutral voltage or if no neutral is present each phase to phase voltage shall be evaluated. At voltage re-entry into the voltage range, 90% of pre-fault power or available power, whichever is the smallest, shall be resumed as fast as possible, but at the latest according to 4.5.3 and 4.5.4. All described settings are defined by the DSO and the responsible party. If no settings are provided, the function shall be disabled. The enabling and disabling and the settings shall be field adjustable and means have to be provided to protect these from unpermitted interference (e.g. password or seal) if required by the DSO.	Test with 4.5.3	P
4.7.4.2.3	Induction generator based units In general no voltage support during faults and voltage steps is required from generating plants connected in LV distribution networks as the additional reactive current is expected to interfere with grid protection equipment.		N/A

EN 50549-1:2019			
Clause	Requirement - Test	Result - Remark	Verdict
4.7.4.3	<p>Generating plant with synchronous generating technology - Synchronous generator based units In general no voltage support during faults and voltage steps is required from generating plants connected in LV distribution networks as the additional reactive current is expected to interfere with grid protection equipment. If the responsible party requires voltage support during faults and voltage steps for generating plants of type B connected to LV distribution grids, the clause 4.7.4 of EN50549-2 applies.</p>		P
4.8	<p>EMC and power quality Similar to any other apparatus or fixed installation, generating units shall comply with the requirements on electromagnetic compatibility established in Directive 2014/30/EU or 2014/53/EU, whichever applies. EMC limits and tests, described in EN 61000 series, have been traditionally developed for loads, without taking into account the particularities of generating units, such as their capability to create overvoltages or high frequency disturbances due to the presence of power converters, which were either impossible or less frequent in case of loads.</p>		P
4.9	<p>Interface protection</p>		P
4.9.1	<p>General According to HD 60364-5-551:2010, 551.7.4, means of automatic switching shall be provided to disconnect the generating plant from the distribution network in the event of loss of that supply or deviation of the voltage or frequency at the supply terminals from values declared for normal supply. This automatic means of disconnection has following main objectives:</p> <ul style="list-style-type: none"> • prevent the power production of the generating plant to cause an overvoltage situation in the distribution network it is connected to. Such overvoltages could result in damages to the equipment connected to the distribution network as well as the distribution network itself; • detect unintentional island situations and disconnect the generating plant in this case. This is contributing to prevent damage to other equipment, both in the producers' installations and the distribution network due to out of phase re-closing and to allow for maintenance work after an intentional disconnection of a section of the distribution network. • assist in bringing the distribution network to a controlled state in case of voltage or frequency deviations beyond corresponding regulation values. 		P

EN 50549-1:2019			
Clause	Requirement - Test	Result - Remark	Verdict
	<ul style="list-style-type: none"> • disconnect the generating plant from the distribution network in case of faults internal to the power generating plant. Protection against internal faults (short-circuits) shall be coordinated with network protection, according to DSO protection criteria. Protection against e.g. overload, electric shock and against fire hazards shall be implemented additionally according to HD 60364-1 and local requirements. • prevent damages to the generating unit due to incidents (e.g. short circuits) on the distribution network Interface protections may contribute to preventing damage to the generating units due to out-of-phase reclosing of automatic reclosing which may happen after some hundreds of ms. However, in some countries some technologies of generating units are explicitly required to have an appropriate immunity level against the consequences of out-of-phase reclosing. The type of protection and the sensitivity and operating times depend upon the protection and the characteristics of the distribution network. A wide variety of approaches to achieve the above mentioned objectives is used throughout Europe. Besides the passive observation of voltage and frequency other active and passive methods are available and used to detect island situations. The requirements given in this clause are intended to provide the necessary functions for all known approaches as well as to give guidance in their use. Which functions are available in a product shall be stated in the product documentation. 		P
	<p>The interface protection system shall comply with the requirements of this European Standard, the available functions and configured settings shall comply with the requirements of the DSO and the responsible party. In any case, the settings defined shall be understood as the values for the interface protection system, i.e. where there is a wider technical capability of the generation module, it shall not be withheld by the settings of the protections (other than the interface protection).</p> <p>For micro generating plants, the interface protection system and the point of measurement might be integrated into the generating units. For generating plants with nominal current above 16 A the DSO may define a threshold above which the interface protection system shall be realized as a dedicated device and not integrated into the generating units.</p>	<p>Integrated into the generating units If specified by country requirement, the interface protection shall not be integrated</p>	P

EN 50549-1:2019			
Clause	Requirement - Test	Result - Remark	Verdict
	<p>to place the protection system as close to the point of connection as possible, to avoid tripping due to overvoltages resulting from the voltage rise within the producer's network;</p> <ul style="list-style-type: none"> • to allow for periodic field tests. In some countries periodic field tests are not required if the protection system meets the requirements of single fault safety. <p>The interface protection relay acts on the interface switch. The DSO may require that the interface protection relay acts additionally on another switch with a proper delay in case the interface switch fails to operate.</p> <p>In case of failure of the power supply of the interface protection, the interface protection shall trigger the interface switch without delay. An uninterruptible power supply may be required by the DSO, for instance in case of UVRT capability, delay in protection etc.</p> <p>In case of field adjustable settings of threshold and operation time, means shall be provided to protect the settings from unpermitted interference (e.g. password or seal) if required by the DSO.</p>		P
4.9.2	Void		N/A
4.9.3	Requirements on voltage and frequency protection	See appended table 4.9.3	P
4.9.3.1	<p>General</p> <p>Part or all of the following described functions may be required by the DSO and the responsible party.</p> <p>In case of three phase generating units/plants and in all cases when the protection system is implemented as an external protection system in a three phase power supply system, all phase to phase voltages and, if a neutral conductor is present, all phase to neutral voltages shall be evaluated.</p> <p>The frequency shall be evaluated on at least one of the voltages.</p>		P
	<p>If multiple signals (e.g. 3 phase to phase voltages) are to be evaluated by one protection function, this function shall evaluate all of the signals separately. The output of each evaluation shall be OR connected, so that if one signal passes the threshold of a function, the function shall trip the protection in the specified time.</p> <p>The minimum required accuracy for protection is:</p> <ul style="list-style-type: none"> • for frequency measurement $\pm 0,05$ Hz; • for voltage measurement ± 1 % of U_n. • The reset time shall be ≤ 50ms • The interface protection relay shall not conduct continuous starting and disengaging operations of the interface protection relay. Therefore a reasonable reset ratio shall be implemented which shall not be zero but be below 2% of nominal value for voltage and below 0,2Hz for frequency. 		P

EN 50549-1:2019			
Clause	Requirement - Test	Result - Remark	Verdict
4.9.3.2	<p>Undervoltage protection [27] The protection shall comply with EN 60255-127. The evaluation of the r.m.s. or the fundamental value is allowed. Undervoltage protection may be implemented with two completely independent protection thresholds, each one able to be activated or not. The standard adjustment ranges are as follows.</p> <p>Undervoltage threshold stage 1 [27 <]:</p> <ul style="list-style-type: none"> • Threshold (0,2 – 1) U_n adjustable by steps of 0,01 U_n • Operate time (0,1 – 100) s adjustable in steps of 0,1 s <p>Undervoltage threshold stage 2 [27 < <]:</p> <ul style="list-style-type: none"> • Threshold (0,2 – 1) U_n adjustable by steps of 0,01 U_n • Operate time (0,1 – 5) s adjustable in steps of 0,05 s <p>The undervoltage threshold stage 2 is not applicable for micro-generating plants</p>	See appended table 4.9.3.2	P
4.9.3.3	<p>Overvoltage protection [59] The protection shall comply with EN 60255-127. The evaluation of the r.m.s. or the fundamental value is allowed. Overvoltage protection may be implemented with two completely independent protection thresholds, each one able to be activated or not. The standard adjustment ranges are as follows.</p> <p>Overvoltage threshold stage 1 [59 >]:</p> <ul style="list-style-type: none"> • Threshold (1,0 – 1,2) U_n adjustable by steps of 0,01 U_n • Operate time (0,1 – 100) s adjustable in steps of 0,1 s <p>Overvoltage threshold stage 2 [59 > >]:</p> <ul style="list-style-type: none"> • Threshold (1,0 – 1,30) U_n adjustable by steps of 0,01 U_n • Operate time (0,1 – 5) s adjustable in steps of 0,05 s 	See appended table 4.9.3.3	P
4.9.3.4	<p>Overvoltage 10 min mean protection The calculation of the 10 min value shall comply with the 10 min aggregation of EN 61000-4-30 Class S, but deviating from EN 61000-4-30 as a moving window is used. Therefore the function shall be based on the calculation of the square root of the arithmetic mean of the squared input values over 10 min. The calculation of a new 10 min value at least every 3 s is sufficient, which is then to be compared with the threshold value.</p> <ul style="list-style-type: none"> • Threshold (1,0 – 1,15) U_n adjustable by steps of 0,01 U_n • Start time \leq 3s not adjustable • Time delay setting = 0 ms 	See appended table 4.9.3.4	P

EN 50549-1:2019			
Clause	Requirement - Test	Result - Remark	Verdict
4.9.3.5	<p>Underfrequency protection [81 <] Underfrequency protection may be implemented with two completely independent protection thresholds, each one able to be activated or not. The standard adjustment ranges are as follows. Underfrequency threshold stage 1 [81 <]:</p> <ul style="list-style-type: none"> • Threshold (47,0 – 50,0) Hz adjustment by steps of 0,1 Hz • Operate time (0,1 – 100) s adjustable in steps of 0,1 s <p>Underfrequency threshold stage 2 [81 < <]:</p> <ul style="list-style-type: none"> • Threshold (47,0 – 50,0) Hz adjustment by steps of 0,1 Hz • Operate time (0,1 – 5) s adjustable in steps of 0,05 s <p>In order to use narrow frequency thresholds for islanding detection (see 4.9.3.3) it may be required to have the ability to activate and deactivate a stage by an external signal. The frequency protection shall function correctly in the input voltage range between 20 % U_n and 120 % U_n and shall be inhibited for input voltages of less than 20 % U_n. Under 0,2 U_n the frequency protection is inhibited. Disconnection may only happen based on undervoltage protection.</p>	See appended table 4.9.3.5	P
4.9.3.6	<p>Overfrequency protection [81 >] Overfrequency protection may be implemented with two completely independent protection thresholds, each one able to be activated or not. The standard adjustment ranges are as follows.</p> <p>Overfrequency threshold stage 1 [81 >]:</p> <ul style="list-style-type: none"> • Threshold (50,0 - 52,0) Hz adjustment by steps of 0,1 Hz • Operate time (0,1 – 100) s adjustable in steps of 0,1 s <p>Overfrequency threshold stage 2 [81 > >]:</p> <ul style="list-style-type: none"> • Threshold (50,0 - 52,0) Hz adjustment by steps of 0,1 Hz • Operate time (0,1 - 5) s adjustable in steps of 0,05 s <p>In order to use narrow frequency thresholds for islanding detection (see 4.9.3.3) it may be required to have the ability to activate and deactivate a stage by an external signal. The frequency protection shall function correctly in the input voltage range between 20 % U_n and 120 % U_n and shall be inhibited for input voltages of less than 20 % U_n.</p>	See appended table 4.9.3.6	P
4.9.4	Means to detect island situation		P
4.9.4.1	<p>General sides the passive observation of voltage and frequency further means to detect an island may be required by the DSO. Detecting islanding situations shall not be contradictory to the immunity requirements of 4.5. Commonly used functions include:</p> <ul style="list-style-type: none"> • Active methods tested with a resonant circuit; • ROCOF tripping; • Switch to narrow frequency band; • Vector shift • Transfer trip. <p>Only some of the methods above rely on standards. Namely for ROCOF tripping and for the detection of a vector shift, also called a vector jump, currently no European Standard is available.</p>		P
4.9.4.2	<p>Active methods tested with a resonant circuit These are methods which pass the resonant circuit test for PV inverters according to EN 62116</p>	See appended table 4.9.4	P

EN 50549-1:2019			
Clause	Requirement - Test	Result - Remark	Verdict
4.9.4.3	<p>Switch to narrow frequency band (see Annex E and Annex F) In case of local phenomena (e.g. a fault or the opening of circuit breaker along the line) the DSO in coordination with the responsible party may require a switch to a narrow frequency band to increase the interface protection relay sensitivity. In the event of a local fault it is possible to enable activation of the restrictive frequency window (using the two underfrequency/overfrequency thresholds described in 4.9.2.5 and 4.9.2.6) correlating its activation with another additional protection function. If required by the DSO, a digital input according to 4.9.4 shall be available to allow the DSO the activation of a restrictive frequency window by communication.</p>		P
4.9.5	<p>Digital input to the interface protection If required by the DSO, the interface protection shall have at least two configurable digital inputs. These inputs can for example be used to allow transfer trip or the switching to the narrow frequency band.</p>		P
4.10	Connection and starting to generate electrical power		P
4.10.1	<p>General Connection and starting to generate electrical power is only allowed after voltage and frequency are within the allowed voltage and frequency ranges for at least the specified observation time. It shall not be possible to overrule these conditions. Within these voltage and frequency ranges, the generating plant shall be capable of connecting and starting to generate electrical power. The setting of the conditions depends on whether the connection is due to a normal operational startup or an automatic reconnection after tripping of the interface protection. In case the settings for automatic reconnection after tripping and starting to generate power are not distinct in a generating plant, the tighter range and the start-up gradient shall be used. The frequency range, the voltage range, the observation time and the power gradient shall be field adjustable. For field adjustable settings, means shall be provided to protect the settings from unpermitted interference (e.g. password or seal) if required by the DSO.</p>		P
4.10.2	<p>Automatic reconnection after tripping The frequency range, the voltage range, the observation time shall be adjustable in the range according to Table 3 column 2. If no settings are specified by the DSO and the responsible party, the default settings for the reconnection after tripping of the interface protection are according to Table 3 column 3. After reconnection, the active power generated by the generating plant shall not exceed a specified gradient expressed as a percentage of the active nominal power of the unit per minute. If no gradient is specified by the DSO and the responsible party, the default setting is 10 % P_n/min. Generating modules for which it is technically not feasible to increase the power respecting the specified gradient over the full power range may connect after 1 min to 10 min (randomized value, uniformly distributed) or later.</p>	See appended table 4.10.2	P

EN 50549-1:2019			
Clause	Requirement - Test	Result - Remark	Verdict
4.10.3	<p>Starting to generate electrical power The frequency range, the voltage range, the observation time shall be adjustable in the range according to Table 4 column 2. If no settings are specified by the DSO and the responsible party, the default settings for connection or starting to generate electrical power due to normal operational startup or activity are according to Table 4 column 3. If applicable, the power gradient shall not exceed the maximum gradient specified by the DSO and the responsible party. Heat driven CHP generating units do not need to keep a maximum gradient, since the start up is randomized by the nature of the heat demand. For manual operations performed on site (e.g. for the purpose of initial start-up or maintenance) it is permitted to deviate from the observation time and ramp rate.</p>	<p>See appended table 4.10.3 Default settings are applied</p>	P
4.10.4	<p>Synchronization Synchronizing a generating plant/unit with the distribution network shall be fully automatic i.e. it shall not be possible to manually close the switch between the two systems to carry out synchronization.</p>		P
4.11	<p>Ceasing and reduction of active power on set point</p>		P
4.11.1	<p>Ceasing active power Generating plants with a maximum capacity of 0,8 kW or more shall be equipped with a logic interface (input port) in order to cease active power output within five seconds following an instruction being received at the input port. If required by the DSO and the responsible party, this includes remote operation.</p>	<p>See appended table 4.11</p>	p
4.11.2	<p>Reduction of active power on set point For generating modules of type B, a generating plant shall be capable of reducing its active power to a limit value provided remotely by the DSO. The limit value shall be adjustable in the complete operating range from the maximum active power to minimum regulating level. The adjustment of the limit value shall be possible with a maximum increment of 10% of nominal power. A generation unit/plant shall be capable of carrying out the power output reduction to the respective limit within an envelope of not faster than 0,66 % P_n/s and not slower than 0,33 % P_n/s with an accuracy of 5 % of nominal power. Generating plants are permitted to disconnect from the network at a limit value below it minimum regulating level. If required by the DSO, this includes remote operation.</p>	<p>See appended table 4.11</p>	P
4.12	<p>Remote information exchange Generating plants whose power is above a threshold to be determined by the DSO and the responsible party shall have the capacity to be monitored by the DSO or TSO control centre or control centres as well as receive operation parameter settings for the functions specified in this European Standard from the DSO or TSO control centre or control centres.</p>		N/A

EN 50549-1:2019			
Clause	Requirement - Test	Result - Remark	Verdict
4.13	<p>Requirements regarding single fault tolerance of interface protection system and interface switch</p> <p>If required in 4.3.2, the interface protection system and the interface switch shall meet the requirements of single fault tolerance.</p> <p>A single fault shall not lead to a loss of the safety functions. Faults of common cause shall be taken into account if the probability for the occurrence of such a fault is significant. Whenever reasonably practical, the individual fault shall be displayed and lead to the disconnection of the power generating unit or system.</p> <p>Series-connected switches shall each have a independent breaking capacity corresponding to the rated current of the generating unit and corresponding to the short circuit contribution of the generating unit.</p> <p>The short-time withstand current of the switching devices shall be coordinated with maximum short circuit power at the connection point.</p> <p>At least one of the switches shall be a switch-disconnector suitable for overvoltage category 2. For single-phase generating units, the switch shall have one contact of this overvoltage category for both the neutral conductor and the line conductor. For poly-phase generating units, it is required to have one contact of this overvoltage category for all active conductors. The second switch may be formed of electronic switching components from an inverter bridge or another circuit provided that the electronic switching components can be switched off by control signals and that it is ensured that a failure is detected and leads to prevention of the operation at the latest at the next reconnection.</p> <p>For PV-inverters without simple separation between the network and the PV generating unit (e.g. PV Inverter without transformer) both switches mentioned in the paragraph above shall be switchdisconnectors with the requirements described therein, although one switching device is permitted to be located between PV array and PV inverter.</p>		P
Annex A	Interconnection guidance		Info
Annex B	Void		Info
Annex C	Parameter Table		Info
Annex D	List of national requirements applicable for generating plants		Info
Annex E	Loss of Mains and overall power system security		Info
Annex F	Examples of protection strategies		Info
Annex H	Relationship between this European standard and the COMMISSION REGULATION (EU) 2016/631		Info

Appendices Table-Testing Result

Table 4.4.2 Operating frequency range				P
Requirement	Frequency range	Time period for operation Minimum requirement	Time period for operation stringent requirement	
	47.0 Hz – 47.5 Hz	Not required	20s	
	47.5 Hz - 48.5Hz	30 min ^a	90 min	
	48.5 Hz - 49.0 Hz	30 min ^a	90 min ^a	
	49.0 Hz - 51.0 Hz	Unlimited	Unlimited	
	51.0 Hz - 51.5 Hz	30 min ^a	90 min	
	51.5 Hz - 52.0 Hz	Not required	15 min	
	a: Respecting the legal framework, it is possible that longer time periods are required by The responsible party in some synchronous areas,			

Frequency (Hz)	F (Hz)- measure	Time (S)-limit	Time (S)	Result
47.00	47.000	20s	>20s	Pass
47.50	47.500	90min	>90min	Pass
48.50	48.500	90min	>90min	Pass
51.00	51.500	90min	>90min	Pass
51.50	52.000	90min	>90min	Pass
52.00	47.000	15min	>15min	Pass

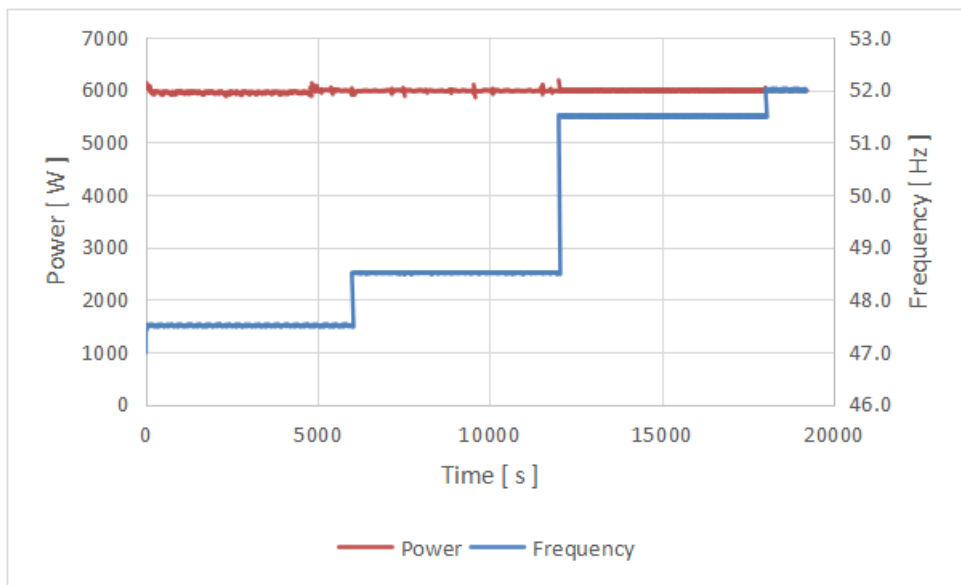

Table 4.4.3 Minimal requirement for active power delivery at underfrequency **P**

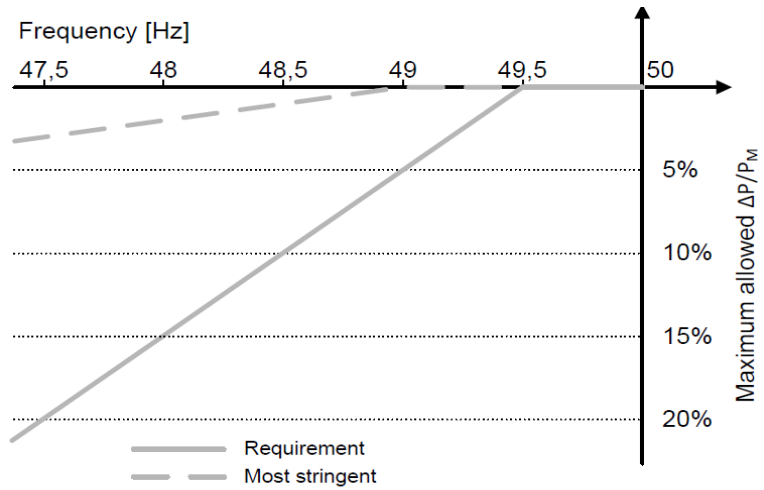

Figure 5 — Maximum allowable power reduction in case of underfrequency

Test result							
Step	f (Hz)	fmea. (Hz)	T (s)	T meas. (s)	P (%) - max	P (%) - min	P meas. (%)
1	50.00 ± 0.05	50.00	>60	70	100%	100%	100.61%
2	49.50 ± 0.05	49.50	>60	70	100%	100%	100.63%
3	49.00 ± 0.05	49.00	>60	70	100%	100%	100.59%
4	48.50 ± 0.05	48.50	>60	70	100%	99%	100.55%
5	48.00 ± 0.05	48.00	>60	70	100%	98%	100.57%
6	47.50 ± 0.05	47.50	>60	70	100%	97%	100.59%

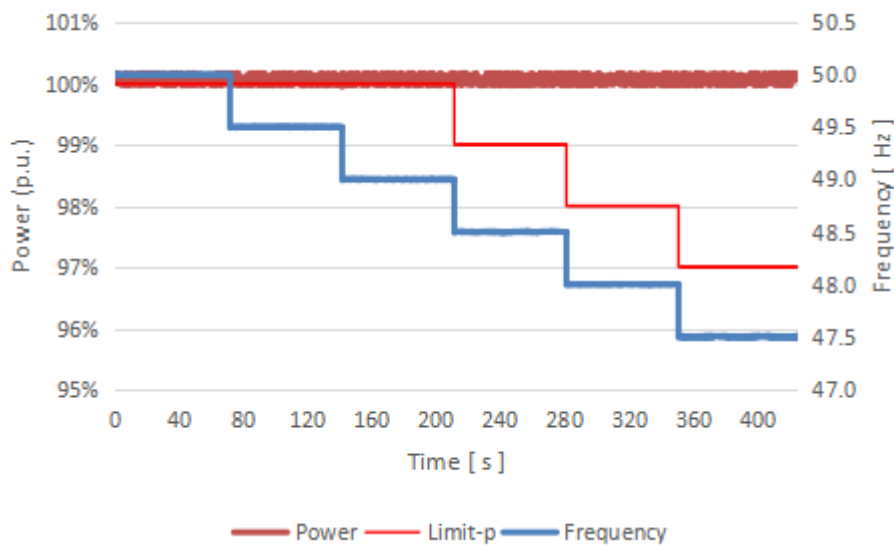

Table 4.4.4 Continuous voltage operation range					P
Test result					
Step	Voltage (%)	P (%)	P meas. (%)	Time (s)	T meas (s)
1	100	100	100.32	>60	85
2	85	100 (*)	90.77	>120	170
3	100	100	100.23	>5	30
4	110	100	100.57	>120	180

(*) Active power reduction is allowed due to current limitation.

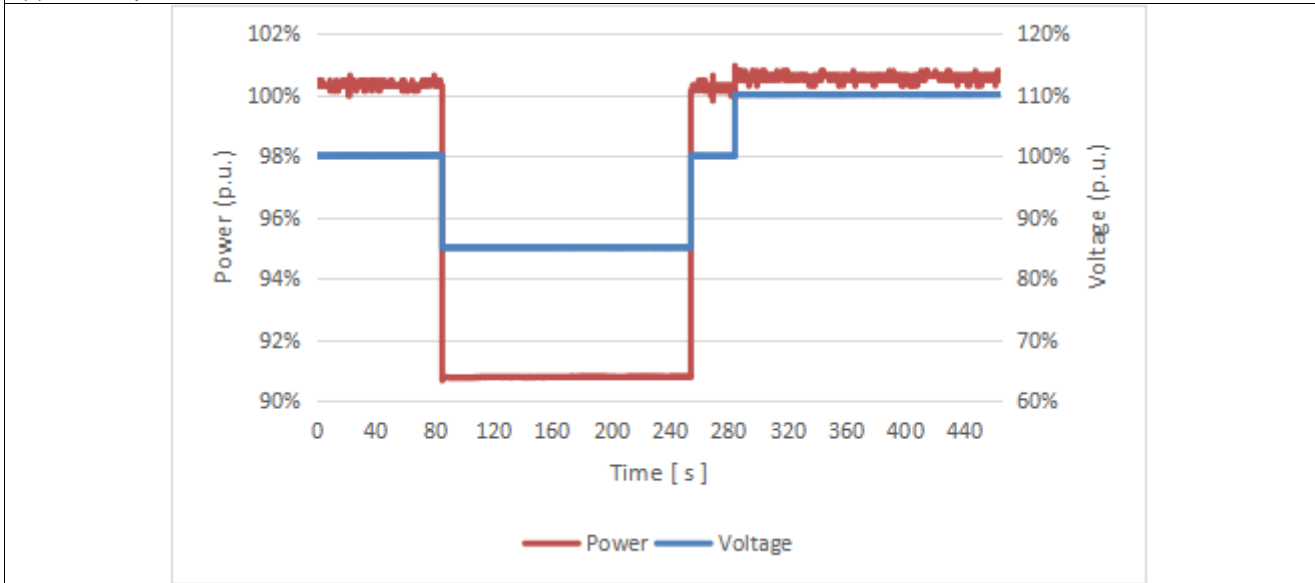
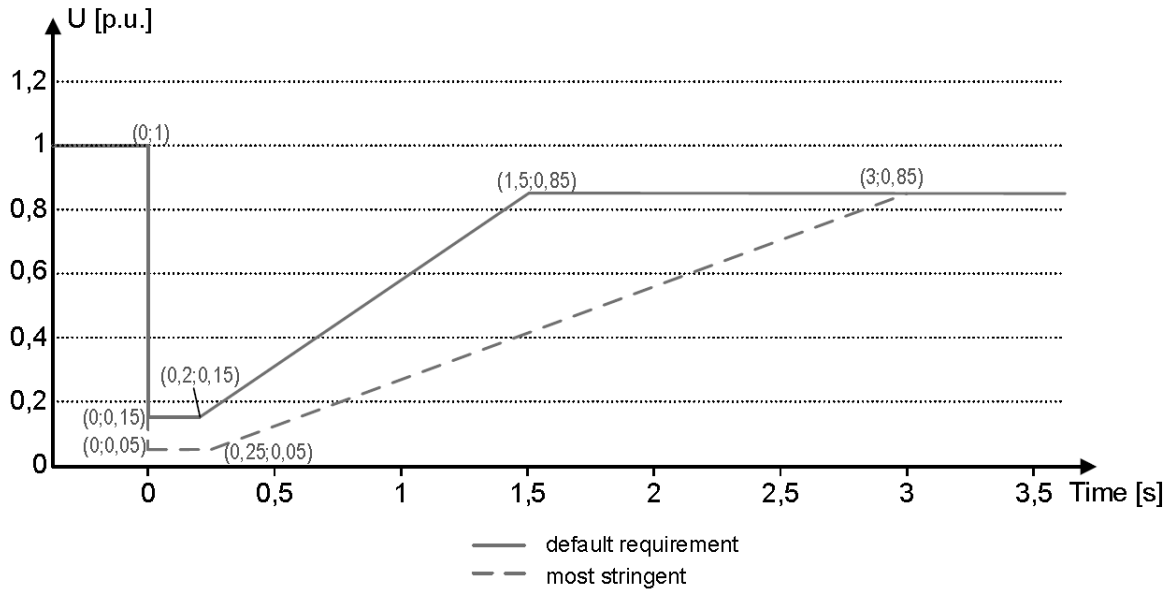

Table 4.5.2 Rate of change of frequency (ROCOF)						P
Test result						
Steps	f (Hz)	Δt (s) step change	Step time	f meas. (Hz)	t meas. (s)	
1	50.00 ± 0.05	--	>10 s	50.00	30	
2	52.00 ± 0.05	< 1 s	>10 s	52.00	30	
3	50.00 ± 0.05	< 1 s	>10 s	50.00	30	
4	48.00 ± 0.05	< 1 s	>10 s	48.00	30	
5	50.00 ± 0.05	< 1 s	>10 s	50.00	30	

The graph displays Power [W] on the left y-axis (0 to 7000) and Frequency [Hz] on the right y-axis (47.0 to 53.0) against Time [s] on the x-axis (0 to 150). A red line represents Power, which remains constant at approximately 6000 W. A blue line represents Frequency, which starts at 50.00 Hz, steps up to 52.00 Hz at 30s, steps down to 50.00 Hz at 60s, steps down to 48.00 Hz at 90s, and steps up to 50.00 Hz at 120s.

This zoomed-in graph shows Power [W] on the left y-axis (0 to 7000) and Frequency [Hz] on the right y-axis (49.0 to 52.5) against Time [s] on the x-axis (30 to 34). The red line for Power is constant at approximately 6000 W. The blue line for Frequency ramps linearly from 50.00 Hz at 30s to 52.00 Hz at 34s.

Table 4.5.3 UVRT **P**



Test result

Test at full load (>90%)

Udip	t min (ms)	U meas. (V)	T meas. (ms)	P recover (s)
5%	250	4.82%	260.1	0.064
25%	938	24.94%	944.1	0.070
50%	1797	49.74%	1803.0	0.062
75%	2656	74.91%	2663.0	0.042

Remark:

The tests are performed together with clause 4.7.4.2.2 Zero current mode and enabling of default setting: Undervoltage of 50%Un.

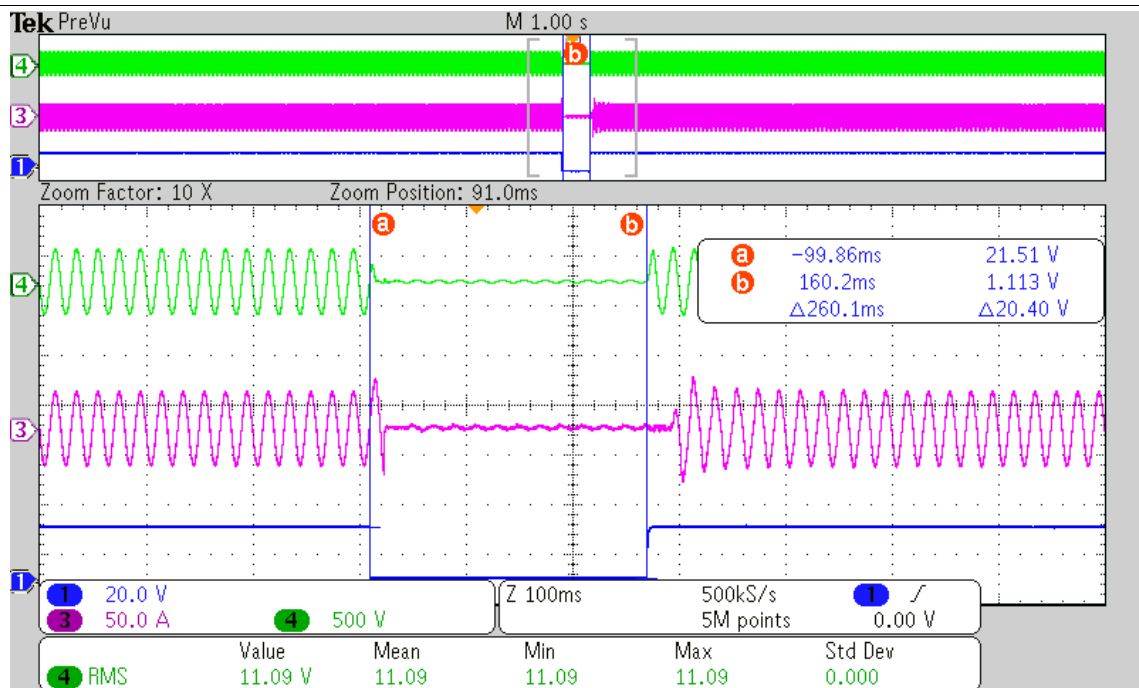

Graph_5%

Table 4.5.3 UVRT

P

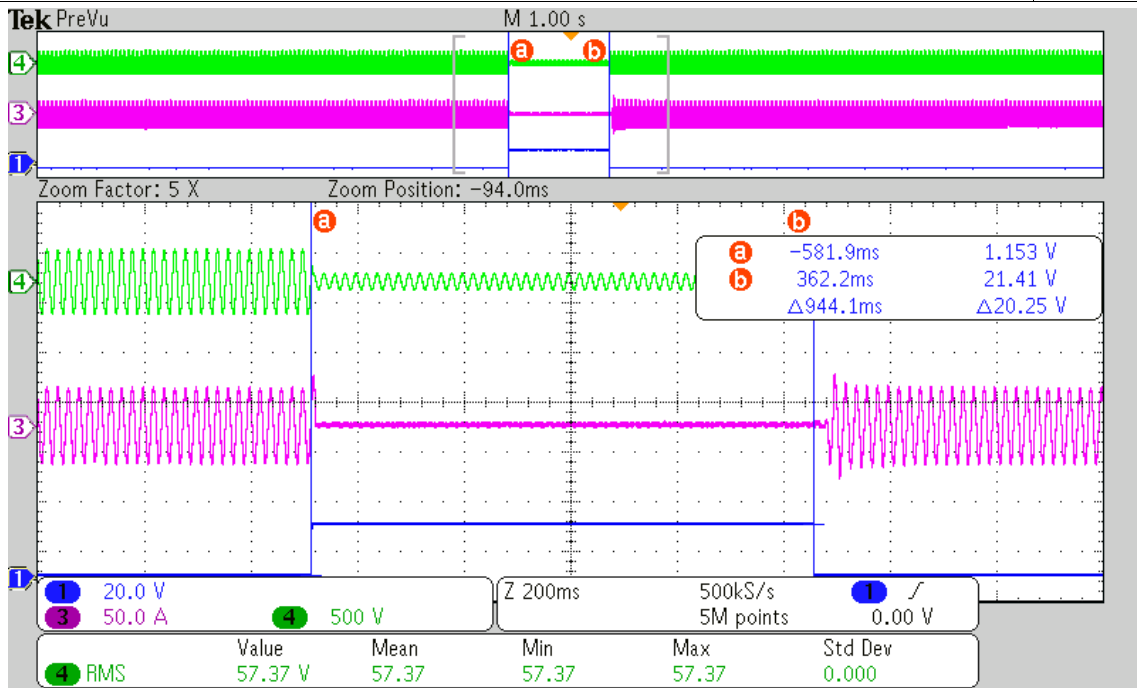

Graph_25%

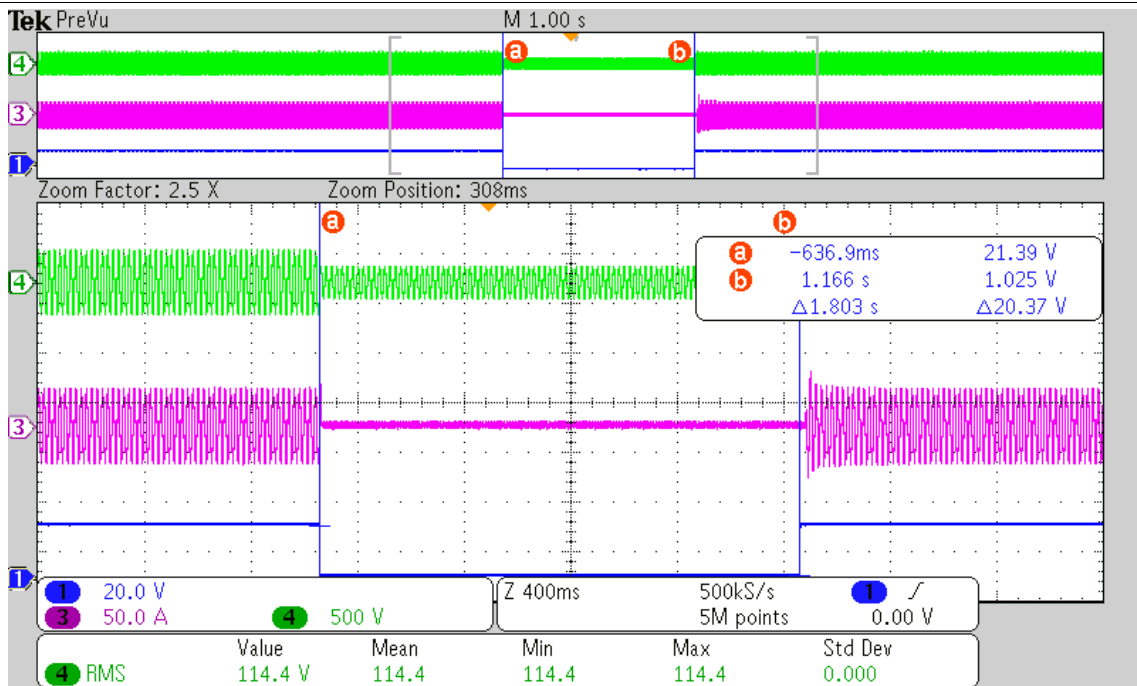

Graph_50%

Table 4.5.3 UVRT

P

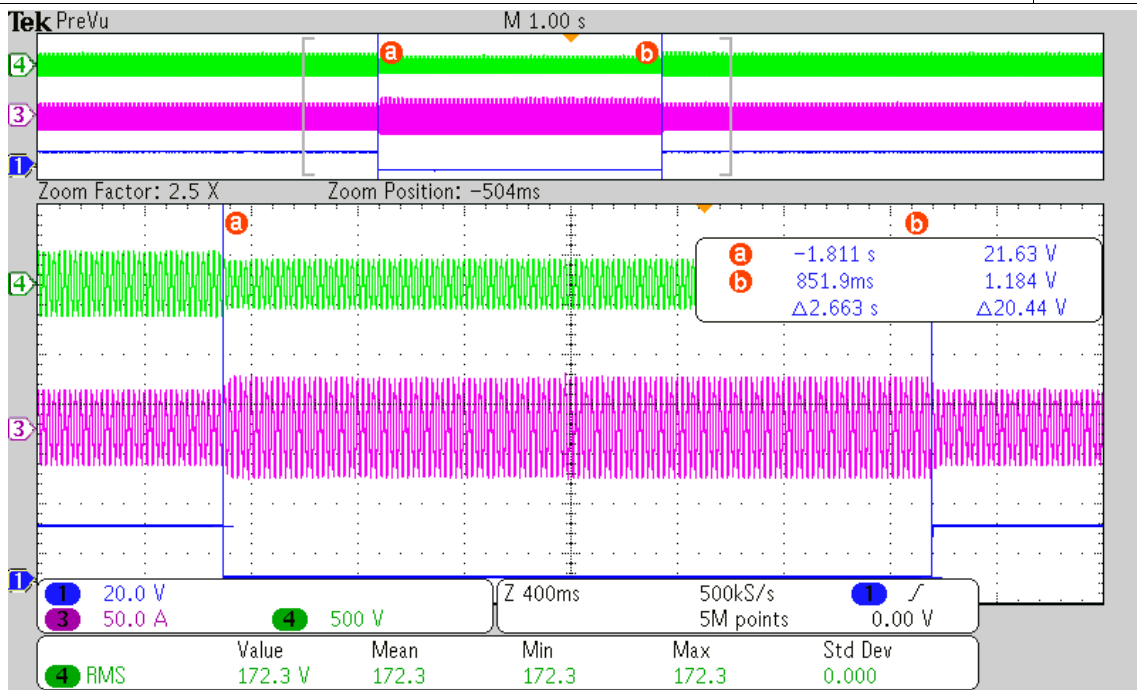

Graph_75%

Table 4.5.3 UVRT **P**

Test result				
Test at partial load (30%)				
Udip	t min (ms)	U meas. (V)	T meas. (ms)	P recover (s)
5%	250	4.77%	250.0	0.012
25%	938	24.47%	938.0	0.042
50%	1797	49.39%	1797.0	0.036
75%	2656	74.87%	2666.0	0.018

Remark:

The tests are performed together with clause 4.7.4.2.2 Zero current mode and enabling of default setting: Undervoltage of 50%Un.

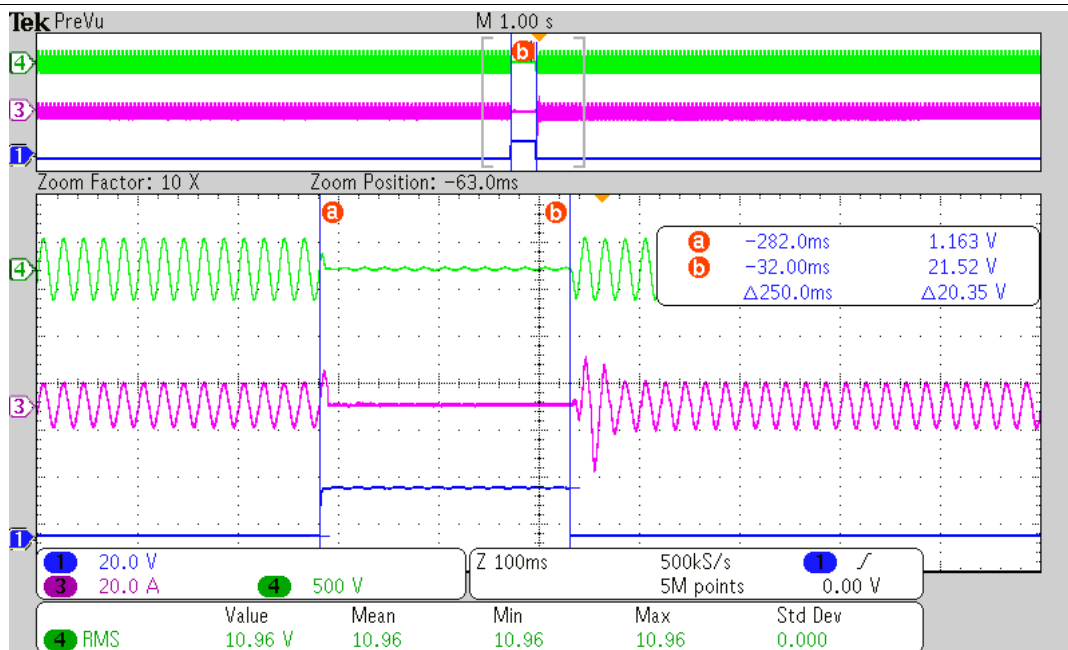

Graph_5%

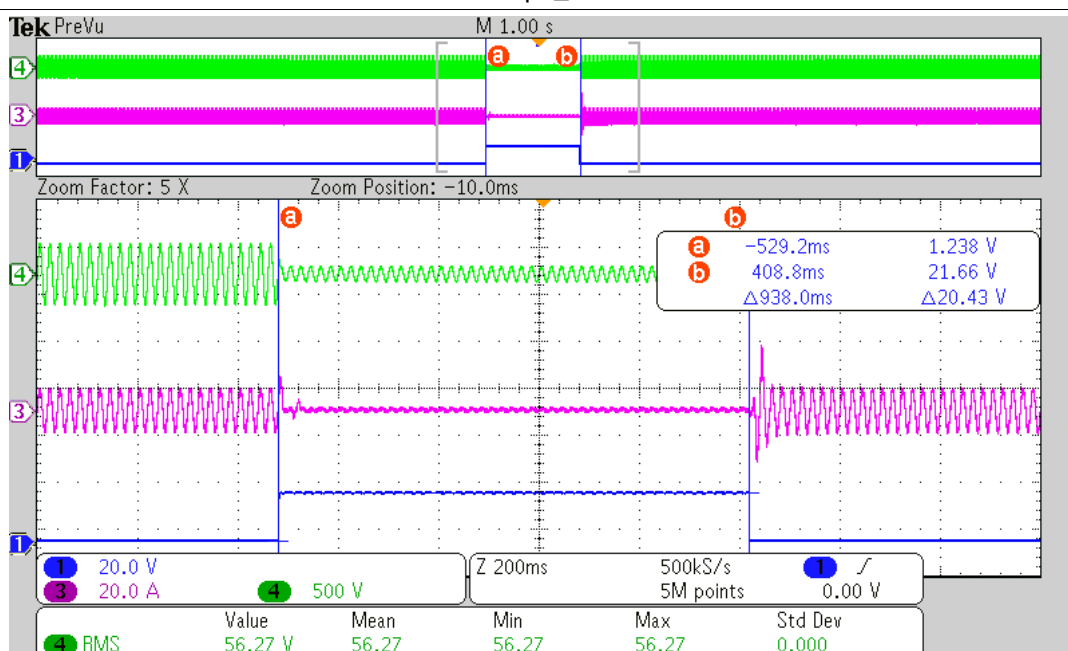

Graph_25%

Table 4.5.3 UVRT

P

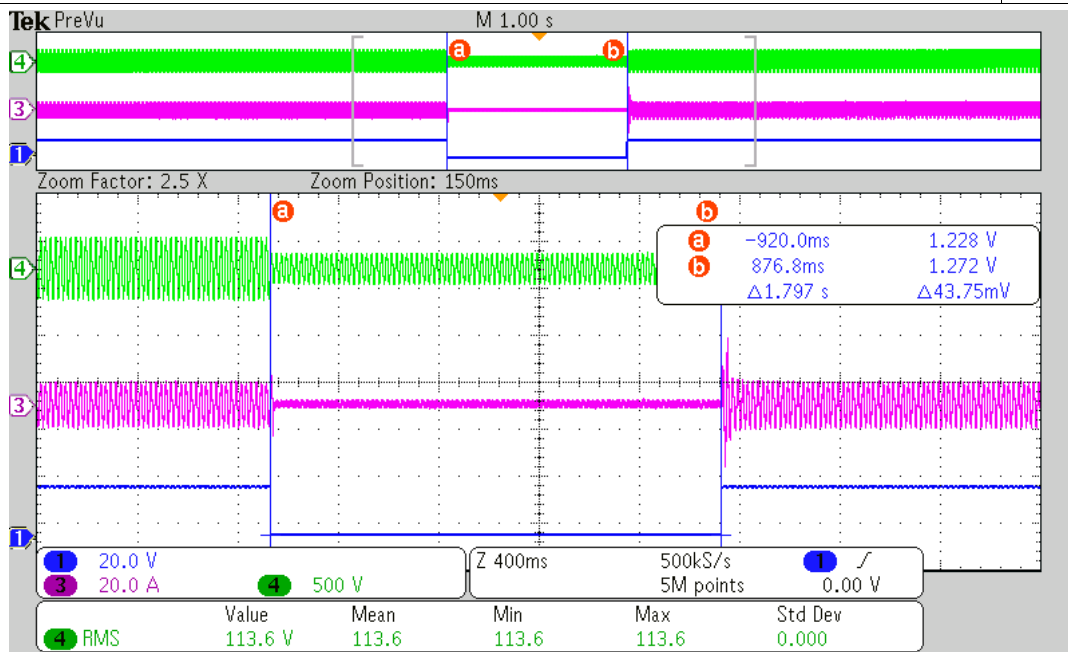

Graph_50%

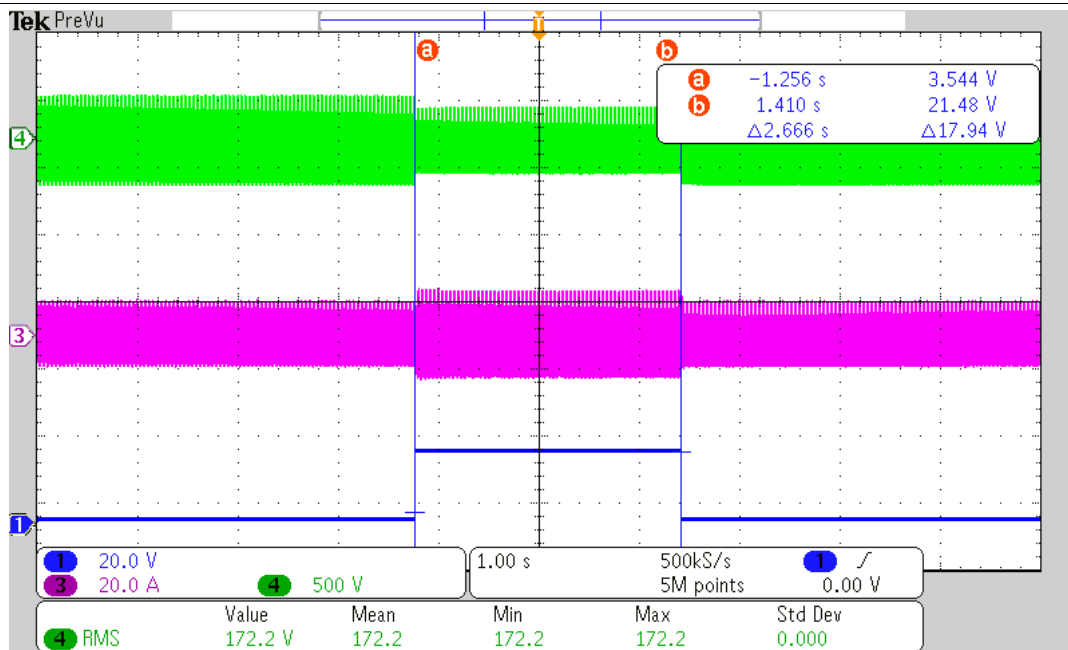

Graph_75%

Table 4.5.4 OVRT **P**

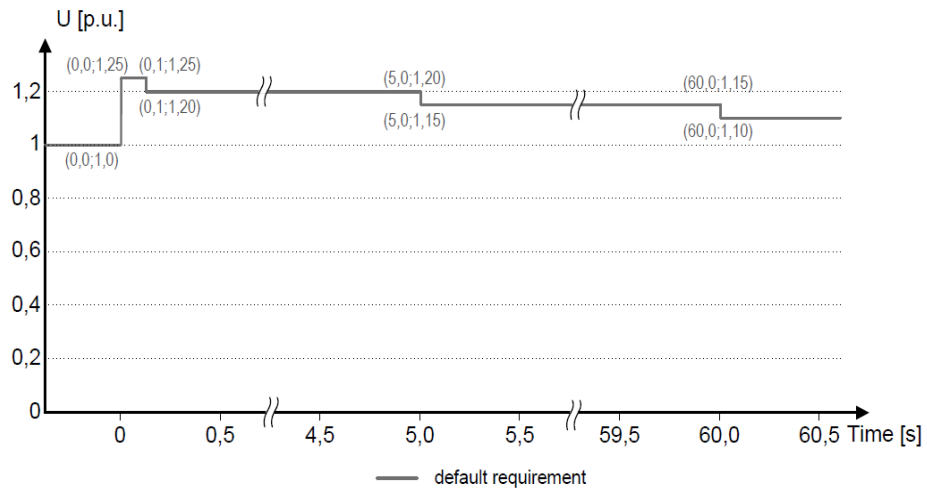

Figure 8 — Over-voltage ride through capability

Test result

Test at full load (>90%)

Udip	t min (ms)	U meas. (%)	T meas. (ms)	P recover (s)
125%	100	125.09%	105.2	0.059
120%	5000	120.43%	5006	0.064
115%	60000	115.48%	60040	0.045

Remark:

The tests are performed together with clause 4.7.4.2.2 Zero current mode and enabling of default setting: Overvoltage of 120%Un.

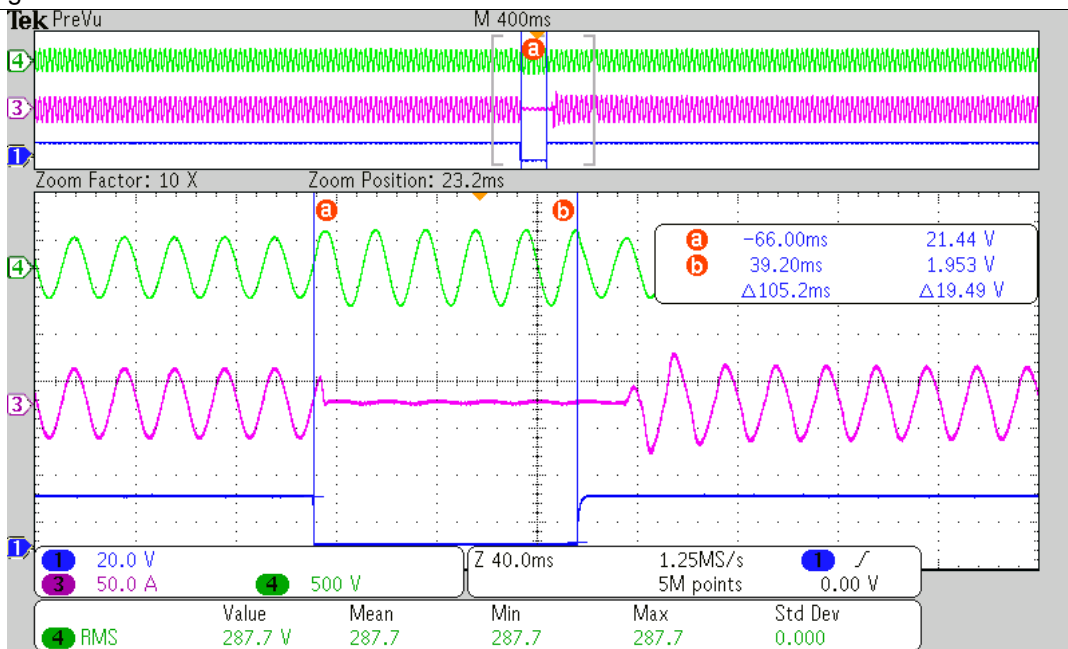

Graph_125%

Table 4.5.4 OVRT

P

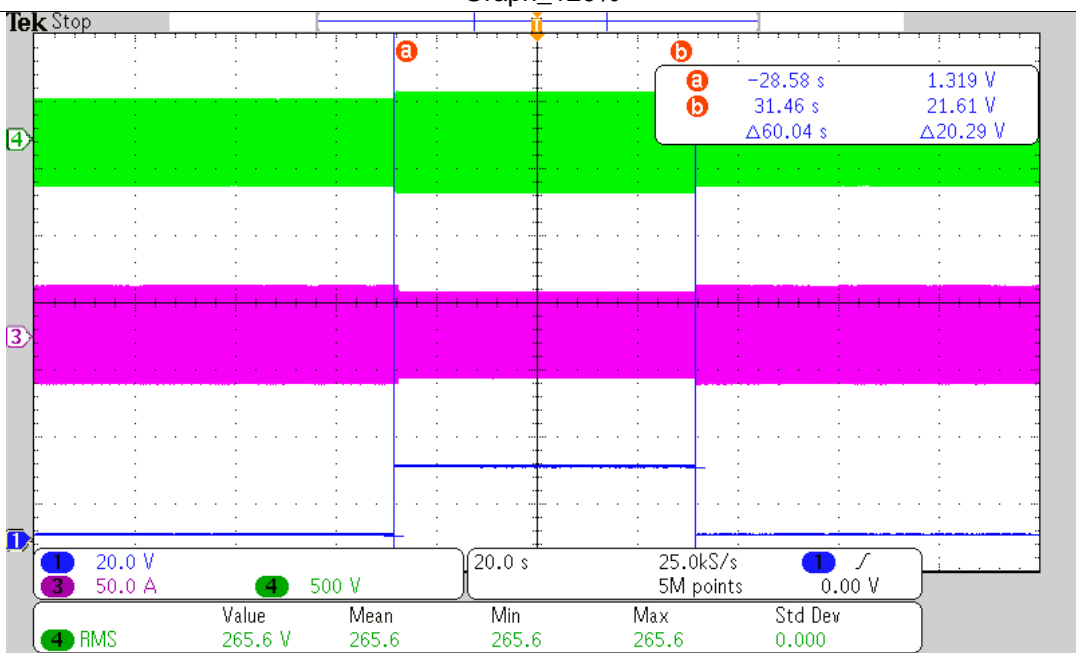
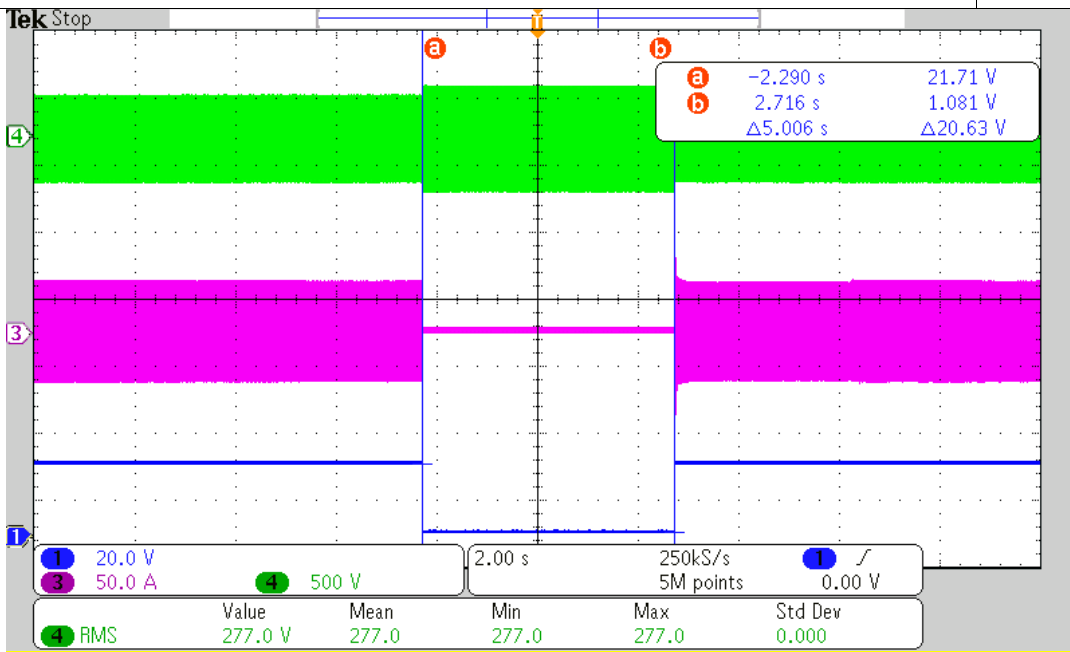

Test at partial load (20%Pn)

Udip	T min (ms)	U meas. (%)	T meas. (ms)	P recover (s)
125%	100	125.13%	106.0	0.058
120%	5000	120.39%	5004.0	0.064
115%	60000	115.30%	60040.0	0.044

Remark:

The tests are performed together with clause 4.7.4.2.2 Zero current mode and enabling of default setting: Overvoltage of 120%Un.

Table 4.5.4 OVRT

P

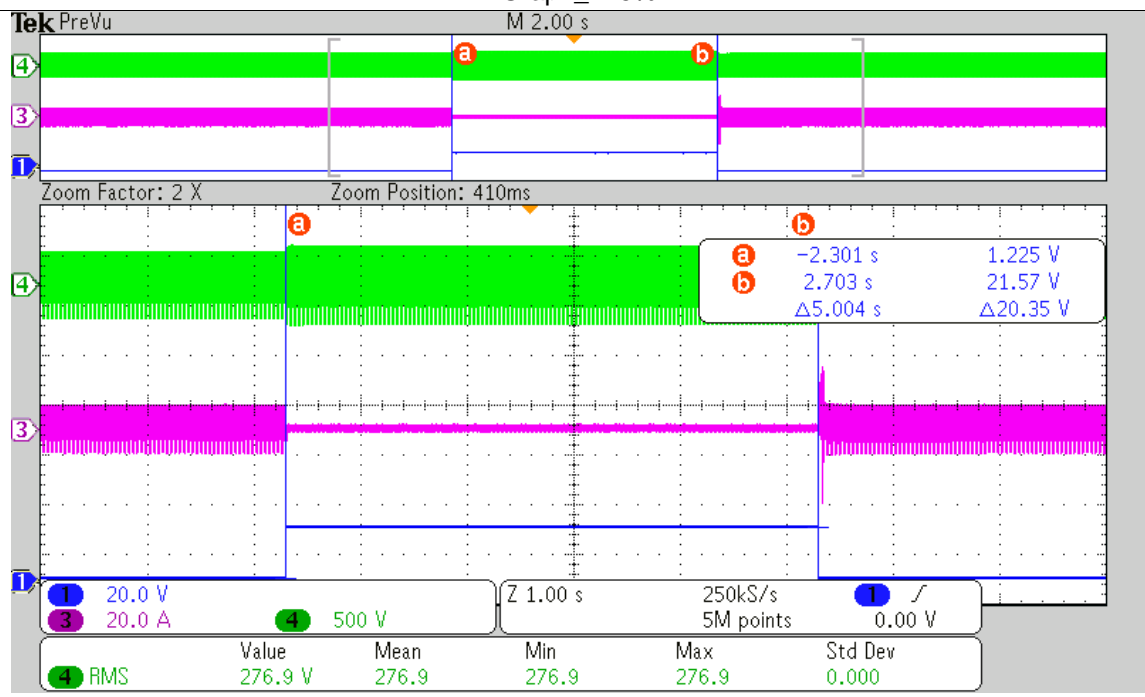
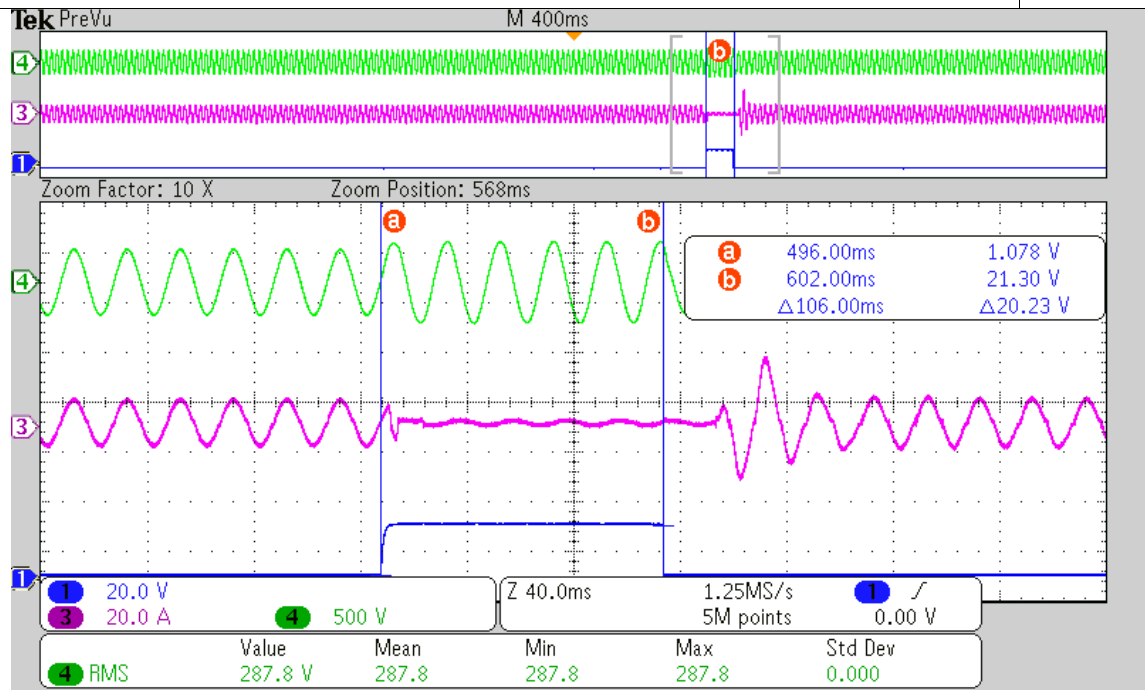
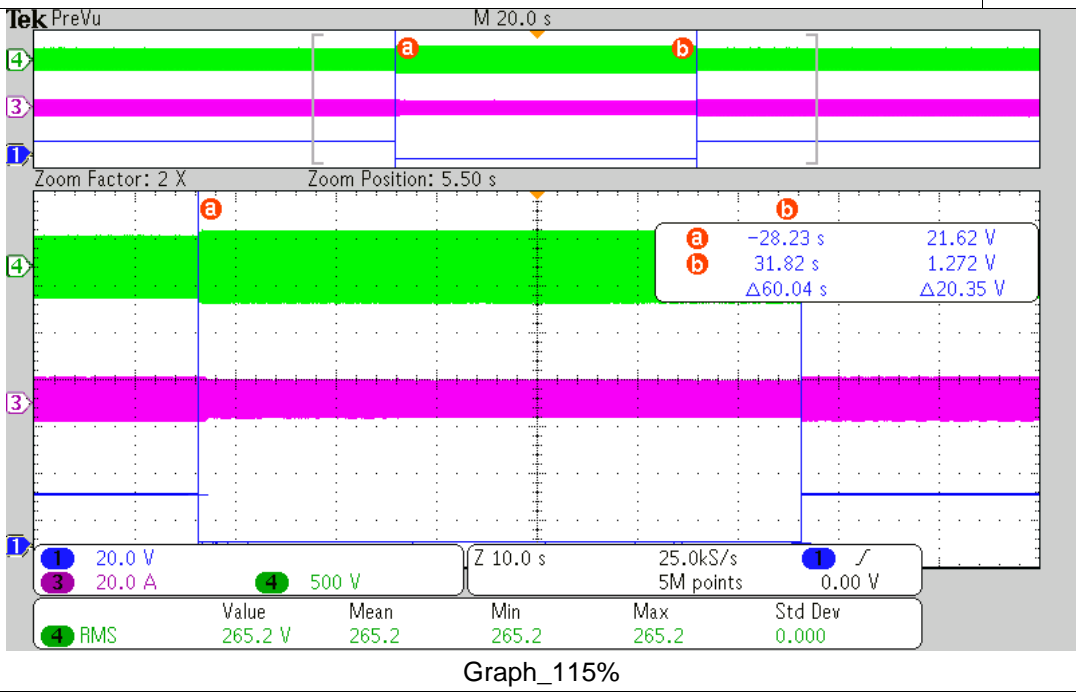

Table 4.5.4 OVRT

P



4.6.1	Table: Power response to over frequency						P
Discharging and Grid tied mode							
Test 1	100% Pn, f1 =50.2Hz; droop=12%; f-stop deactivated, with delay of 2 s						
	f (Hz)	Measured output Power (W)	Calculated from standard characteristic curve P (W)	Tolerance between measured P and calculated P (W)	Tolerance Limit (W)	For a reduction of active power of 50% Pmax T≤2s	For a reduction of active power T≤20s
50Hz ± 0.01Hz	50.00	6000.12	6000.00	--	--	--	--
50.2Hz ± 0.01Hz	50.20	5992.57	6000.00	--	--	--	--
50.70Hz ± 0.01Hz	50.70	5541.86	5500.00	41.86	± 600	1.4s	1.6s
51.15Hz ± 0.01Hz	51.15	5123.49	5050.00	73.49	± 600	0.4s	0.6s
52.0Hz ± 0.01Hz	52.00	4273.08	4200.00	73.08	± 600	0.2s	0.4s
51.15Hz ± 0.01Hz	51.15	5123.12	5050.00	73.12	± 600	0.2s	0.4s
50.70Hz ± 0.01Hz	50.70	5532.31	5500.00	32.31	± 600	0.4s	0.6s
50.2Hz ± 0.01Hz	50.20	5992.97	6000.00	--	--	0.4s	0.6s
50Hz ± 0.01Hz	50.00	6001.99	6000.00	--	--	--	--
Test 2	100% Pn, f1 =50.2Hz; droop=2%; f-stop deactivated, no delay						
	f (Hz)	Measured output Power (W)	Calculated from standard characteristic curve P (W)	Tolerance between measured P and calculated P (W)	Tolerance Limit (W)	For a reduction of active power of 50% Pmax T≤2s	For a reduction of active power T≤20s
50Hz ± 0.01Hz	50.00	6002.55	--	--	--	--	--
50.2Hz ± 0.01Hz	50.20	5961.62	--	--	--	--	--
50.70Hz ± 0.01Hz	50.70	3017.67	3000.00	17.67	± 600	0.2s	0.4s
51.15Hz ± 0.01Hz	51.15	451.08	300.00	151.08	± 600	0.4s	0.6s
52.0Hz ± 0.01Hz	52.00	21.92	0.00	21.92	± 600	0.2s	0.4s
51.15Hz ± 0.01Hz	51.15	467.10	300.00	167.10	± 600	0.2s	0.4s
50.70Hz ± 0.01Hz	50.70	3067.00	3000.00	67.00	± 600	0.2s	0.4s
50.2Hz ± 0.01Hz	50.20	5995.72	--	--	--	0.2s	0.4s
50Hz ± 0.01Hz	50.00	6000.32	--	--	--	--	--

4.6.1	Table: Power response to over frequency						P
Discharging and Grid tied mode							
Test 3	50% Pn, f1 =52.0Hz; droop=5%; f-stop deactivated, no delay						
	f (Hz)	Measured output Power (W)	Calculated from standard characteristic curve P (W)	Tolerance between measured P and calculated P (W)	Tolerance Limit (W)	For a reduction of active power of 50% Pmax T≤2s	For a reduction of active power T≤20s
50Hz ± 0.01Hz	50.00	3033.83	--	--	--	--	--
51.0Hz ± 0.01Hz	51.00	3040.12	3000.00	40.12	± 600	--	--
51.70Hz ± 0.01Hz	51.70	3040.51	3000.00	40.51	± 600	--	--
52.0Hz ± 0.01Hz	52.00	3041.93	3000.00	41.93	± 600	--	--
51.70Hz ± 0.01Hz	51.70	3041.66	3000.00	41.66	± 600	--	--
51.00Hz ± 0.01Hz	51.00	3041.98	3000.00	41.98	± 600	--	--
50Hz ± 0.01Hz	50.00	3036.21	--	--	--	--	--
Test 4	100% Pn, f1 =50.2Hz; droop=5%; f-stop =50.1, no delay, Deactivation time tstop 30s						
	f (Hz)	Measured output Power (W)	Calculated from standard characteristic curve P (W)	Tolerance between measured P and calculated P (W)	Tolerance Limit (W)	For a reduction of active power of 50% Pmax T≤2s	For a reduction of active power T≤20s
50Hz ± 0.01Hz	50.00	5993.25	6000	--	--	--	--
50.2Hz ± 0.01Hz	50.20	5983.82	6000	--	--	--	--
50.70Hz ± 0.01Hz	50.70	4698.45	4800	-101.55	± 600	0.2s	0.6s
51.15Hz ± 0.01Hz	51.15	3663.67	3720	-56.33	± 600	0.4s	0.6s
52.0Hz ± 0.01Hz	52.00	1705.47	1680	25.47	± 600	0.4s	0.4s
51.15Hz ± 0.01Hz	51.15	1693.65	1680	13.65	± 600	--	--
50.70Hz ± 0.01Hz	50.70	1693.60	1680	13.60	± 600	--	--
50.2Hz ± 0.01Hz	50.20	1693.39	1680	--	± 600	--	--
50Hz ± 0.01Hz	50.00	5999.72	6000	--	--	--	--

4.6.1	Table: Power response to over frequency	P
-------	---	---

Discharging and Grid tied mode

Test 1_Graph

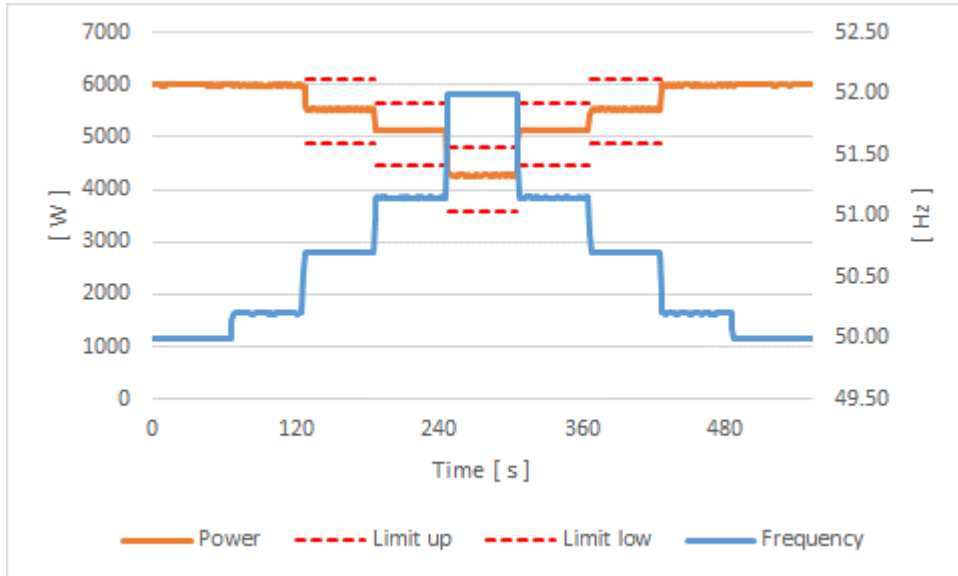

Intentional delay time (2s)



4.6.1	Table: Power response to over frequency	P
-------	---	---

Discharging and Grid tied mode

Test 2_Graph

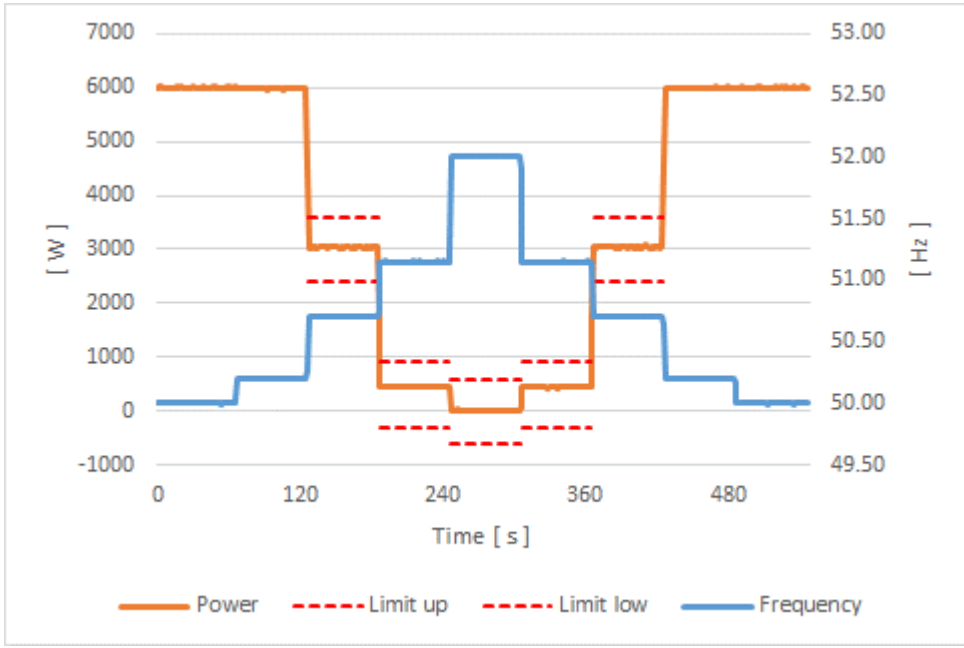

Step response time ($T \leq 2s$)

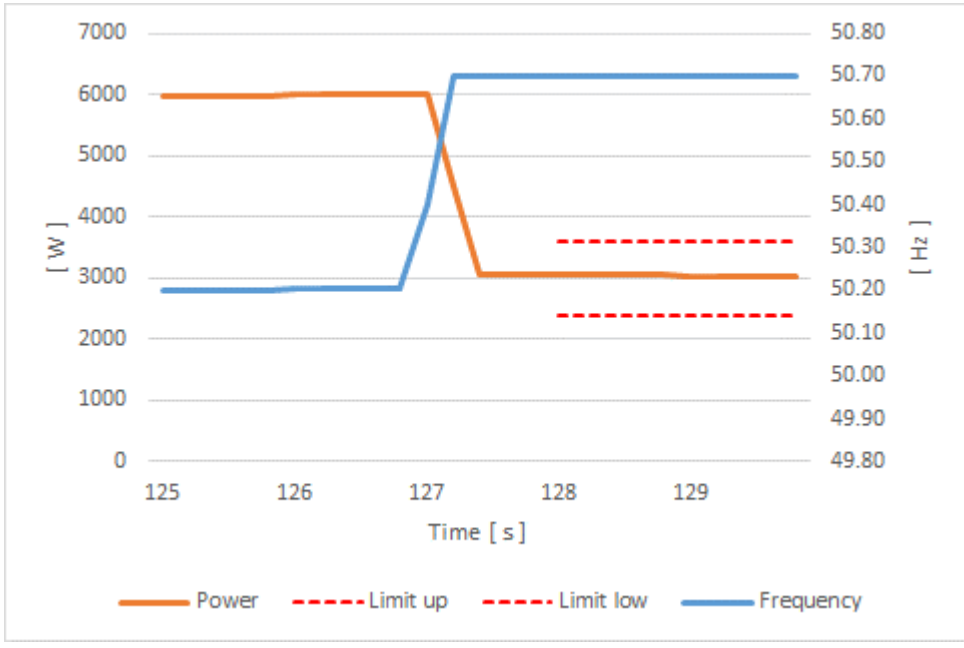

4.6.1	Table: Power response to over frequency	P
-------	---	---

Discharging and Grid tied mode

Test 3_Graph

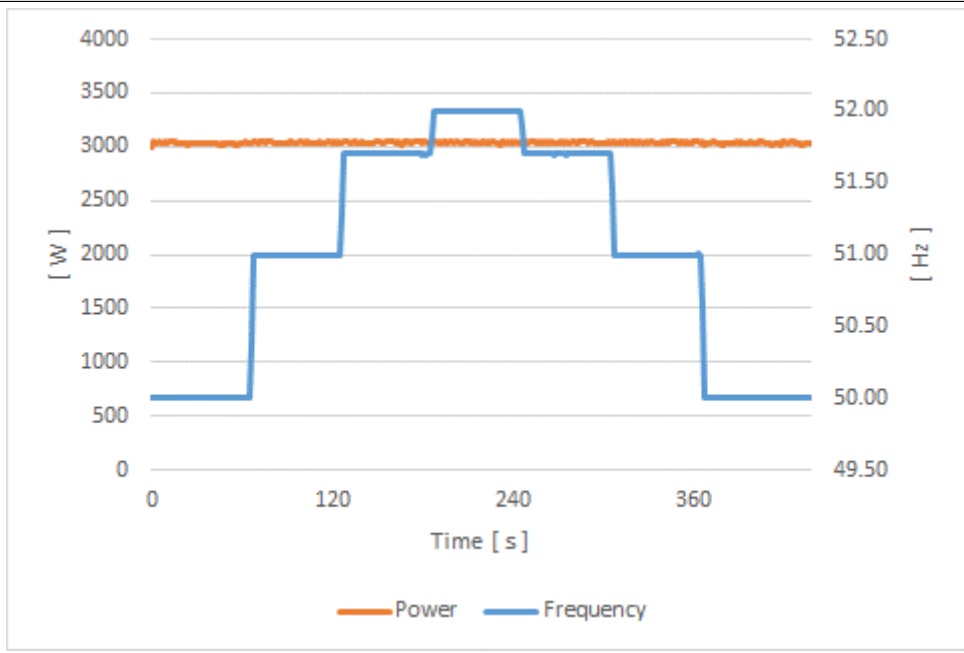

Test 4_Graph

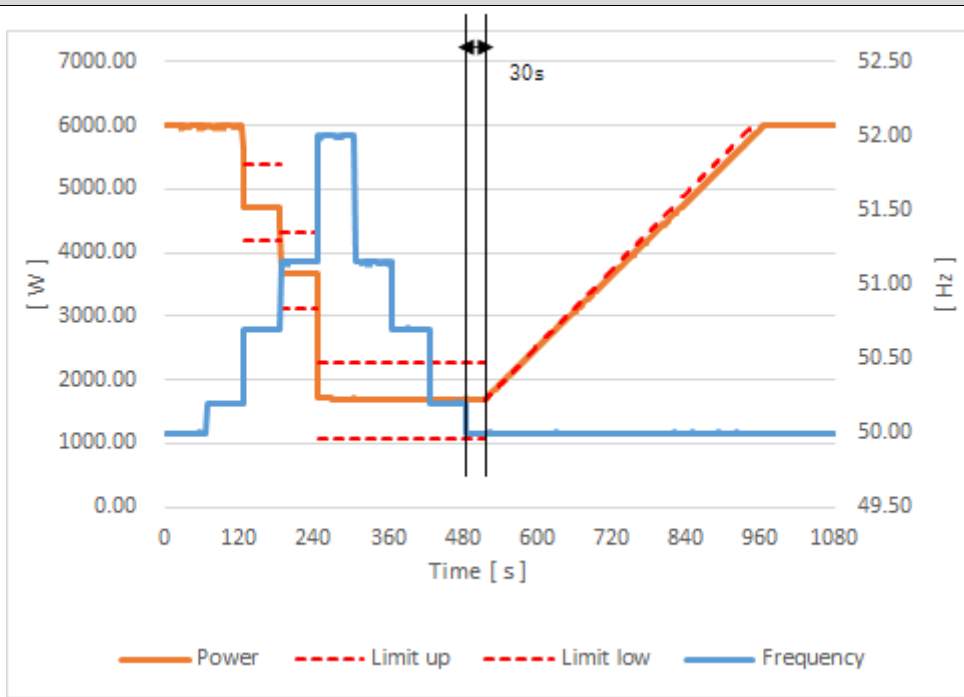

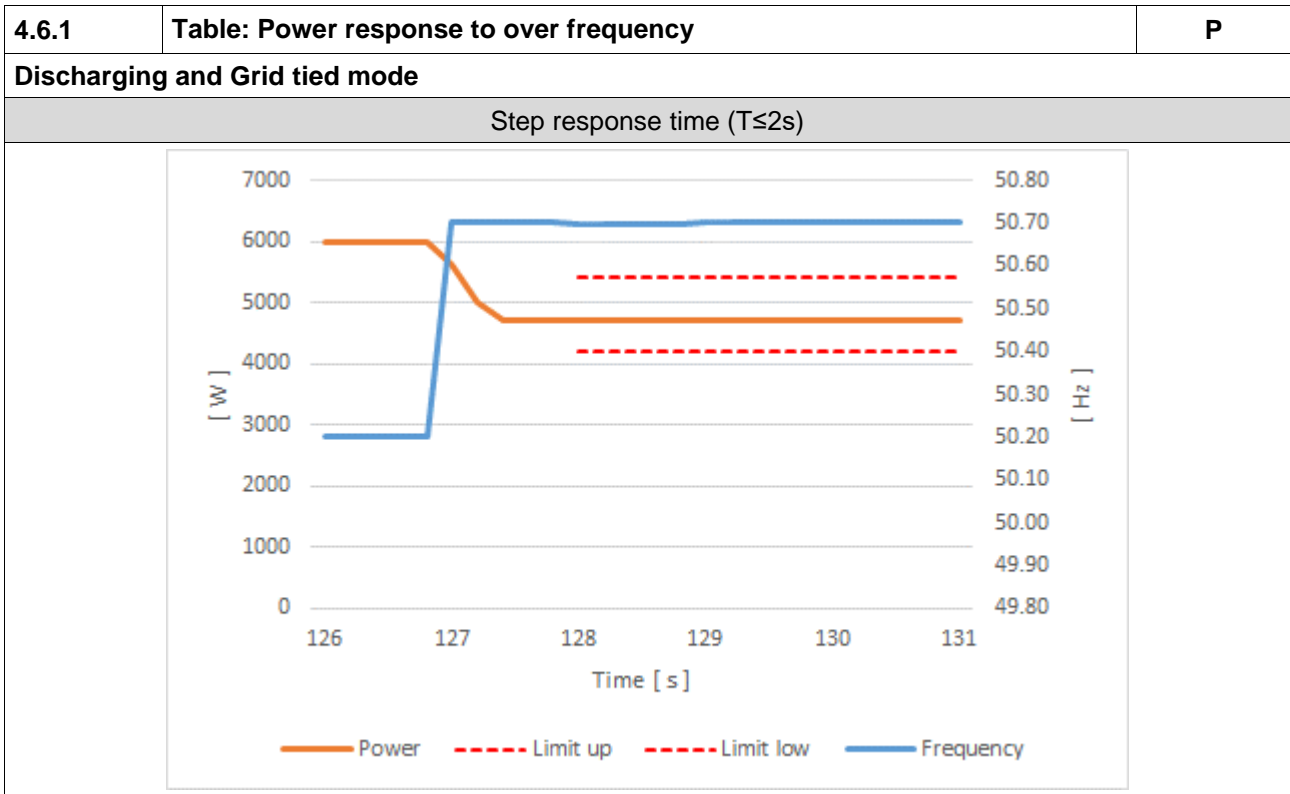

4.6.1	Table: Power response to over frequency						P
Charging mode							
Test 1	-50% Pn, f1 =50.2Hz; droop=12%; f-stop deactivated, with delay of 2 s						
	f (Hz)	Measured output Power (W)	Calculated from standard characteristic curve P (W)	Tolerance between measured P and calculated P (W)	Tolerance Limit (W)	For a reduction of active power of 50% Pmax T≤2s	For a reduction of active power T≤20s
	50Hz ± 0.01Hz	50.00	-2409.58	-2400	--	--	--
	50.2Hz ± 0.01Hz	50.20	-2409.09	-2400	--	--	--
	50.70Hz ± 0.01Hz	50.70	-2792.75	-2800	7.25	± 480	1.0s
	51.15Hz ± 0.01Hz	51.15	-3144.90	-3160	15.10	± 480	0.2s
	52.0Hz ± 0.01Hz	52.00	-3806.88	-3840	33.12	± 480	0.2s
	51.15Hz ± 0.01Hz	51.15	-3143.45	-3160	16.55	± 480	0.2s
	50.70Hz ± 0.01Hz	50.70	-2793.95	-2800	6.05	± 480	0.2s
	50.2Hz ± 0.01Hz	50.20	-2411.40	-2400	--	--	0.4s
50Hz ± 0.01Hz	50.00	-2410.66	-2400	--	--	--	
Test 2	-50% Pn, f1 =50.2Hz; droop=2%; f-stop deactivated, no delay						
	f (Hz)	Measured output Power (W)	Calculated from standard characteristic curve P (W)	Tolerance between measured P and calculated P (W)	Tolerance Limit (W)	For a reduction of active power of 50% Pmax T≤2s	For a reduction of active power T≤20s
	50Hz ± 0.01Hz	50.00	-2409.55	-2400	--	--	--
	50.2Hz ± 0.01Hz	50.20	-2409.75	-2400	--	--	--
	50.70Hz ± 0.01Hz	50.70	-4821.73	-4800	-21.73	± 480	0.4s
	51.15Hz ± 0.01Hz	51.15	-4824.62	-4800	-24.62	± 480	0.4s
	52.0Hz ± 0.01Hz	52.00	-4824.70	-4800	-24.70	± 480	0.2s
	51.15Hz ± 0.01Hz	51.15	-4826.15	-4800	-26.15	± 480	0.2s
	50.70Hz ± 0.01Hz	50.70	-4834.10	-4800	-34.10	± 480	0.2s
	50.2Hz ± 0.01Hz	50.20	-2414.00	-2400	--	--	0.2s
50Hz ± 0.01Hz	50.00	-2407.80	-2400	--	--	--	

4.6.1	Table: Power response to over frequency						P
Charging mode							
Test 3	0% Pn, f1 =52.0Hz; droop=5%; f-stop deactivated, no delay						
	f (Hz)	Measured output Power (W)	Calculated from standard characteristic curve P (W)	Tolerance between measured P and calculated P (W)	Tolerance Limit (W)	For a reduction of active power of 50% Pmax T≤2s	For a reduction of active power T≤20s
50Hz ± 0.01Hz	50.00	-77.94	--	--	--	--	--
51.0Hz ± 0.01Hz	51.00	-78.50	0	-78.50	± 480	--	--
51.70Hz ± 0.01Hz	51.70	-79.02	0	-79.02	± 480	--	--
52.0Hz ± 0.01Hz	52.00	-78.45	0	-78.45	± 480	--	--
51.70Hz ± 0.01Hz	51.70	-77.70	0	-77.70	± 480	--	--
51.00Hz ± 0.01Hz	51.00	-78.17	0	-78.17	± 480	--	--
50Hz ± 0.01Hz	50.00	-75.70	--	--	--	--	--
Test 4	0% Pn, f1 =50.2Hz; droop=5%; f-stop =50.1, no delay, Deactivation time t _{stop} 30s						
	f (Hz)	Measured output Power (W)	Calculated from standard characteristic curve P (W)	Tolerance between measured P and calculated P (W)	Tolerance Limit (W)	For a reduction of active power of 50% Pmax T≤2s	For a reduction of active power T≤20s
50Hz ± 0.01Hz	50.00	-7.69	0	--	--	--	--
50.2Hz ± 0.01Hz	50.20	-7.73	0	--	--	--	--
50.70Hz ± 0.01Hz	50.70	-980.43	-960	-20.43	± 480	0.4s	0.8s
51.15Hz ± 0.01Hz	51.15	-1858.50	-1824	-34.50	± 480	0.2s	0.4s
52.0Hz ± 0.01Hz	52.00	-3476.68	-3456	-20.68	± 480	0.2s	0.6s
51.15Hz ± 0.01Hz	51.15	-3488.90	-3456	-32.90	± 480	--	--
50.70Hz ± 0.01Hz	50.70	-3490.45	-3456	-34.45	± 480	--	--
50.2Hz ± 0.01Hz	50.20	-3491.25	-3456	--	--	--	--
50Hz ± 0.01Hz	50.00	-7.68	0	--	--	--	--

4.6.1	Table: Power response to over frequency	P
Charging mode		
Test 1_Graph		
<p>The graph displays Power [W] on the left y-axis (ranging from -5000 to 0) and Frequency [Hz] on the right y-axis (ranging from 49.50 to 52.50) against Time [s] on the x-axis (ranging from 0 to 500). The Power series (solid orange) starts at -2500W, drops to -3000W at 120s, then to -3500W at 240s, and returns to -2500W at 480s. The Frequency series (solid blue) starts at 50.00Hz, rises to 50.50Hz at 120s, peaks at 52.00Hz between 240s and 300s, and returns to 50.00Hz at 480s. Dashed red lines represent the Limit up and Limit low boundaries.</p>		
Intentional delay time (2s)		
<p>This zoomed-in graph shows the period from 122s to 127s. The Power [W] (solid orange) is constant at -2500W. The Frequency [Hz] (solid blue) rises sharply from 50.00Hz at 122s to 50.70Hz by 122.5s and remains constant. Dashed red lines indicate the Limit up and Limit low boundaries.</p>		

4.6.1	Table: Power response to over frequency	P
-------	---	---

Charging mode

Test 2_Graph

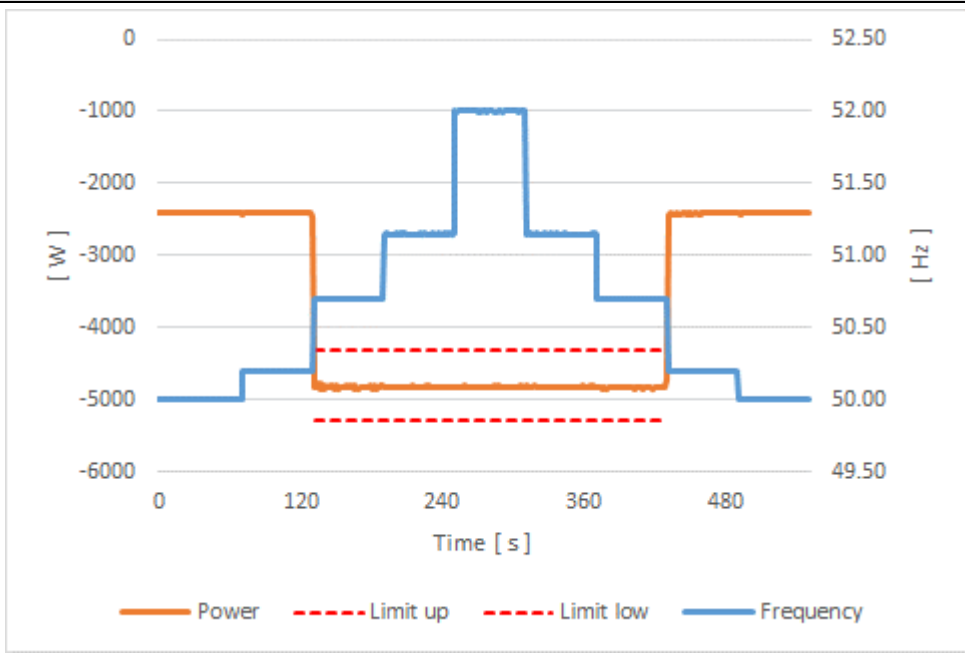

Step response time ($T_{\leq 2s}$)

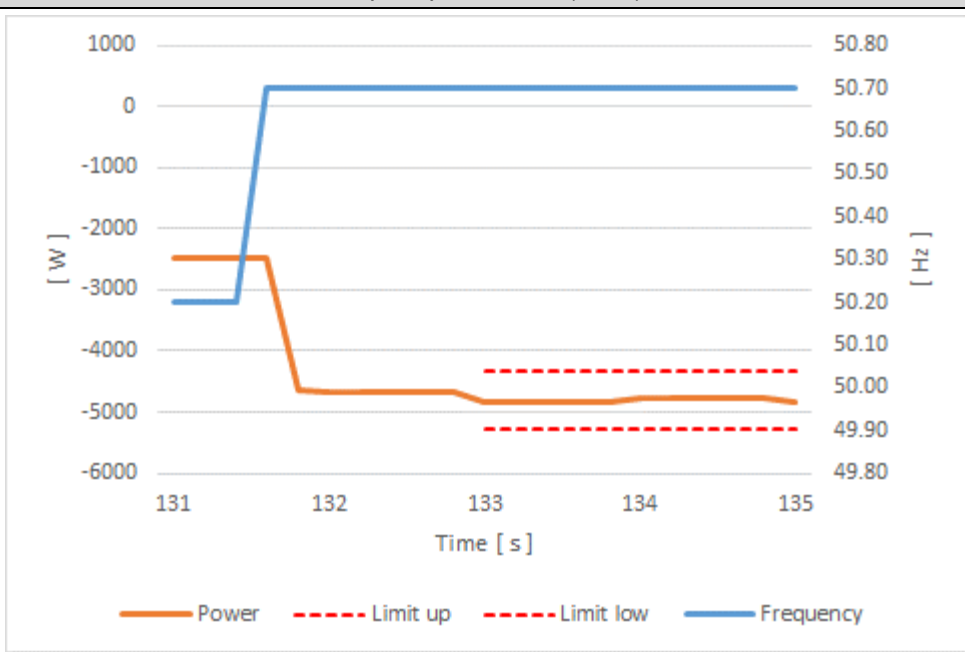

4.6.1	Table: Power response to over frequency	P
-------	---	---

Charging mode

Test 3_Graph

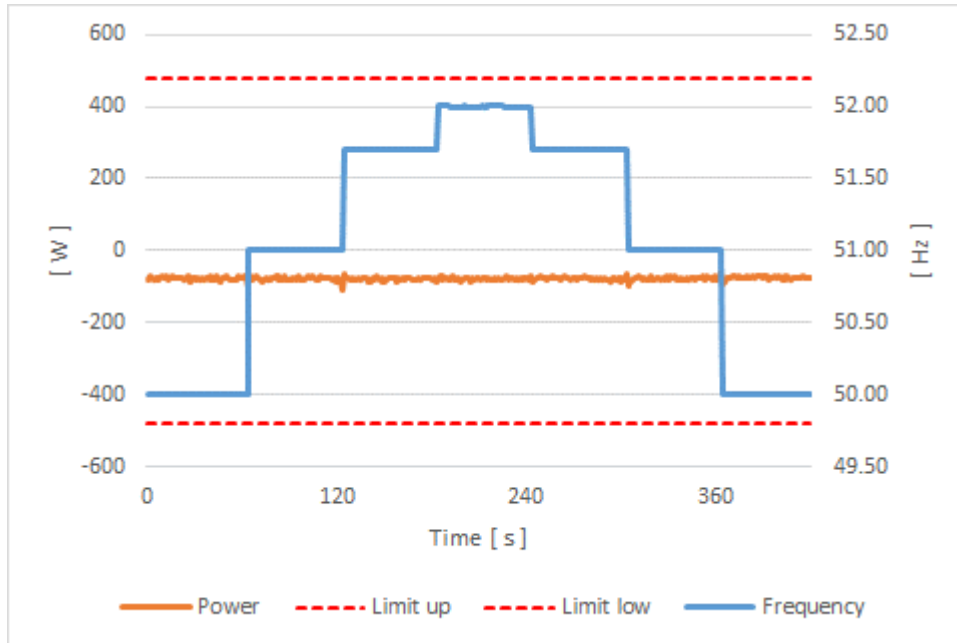

Test 4_Graph

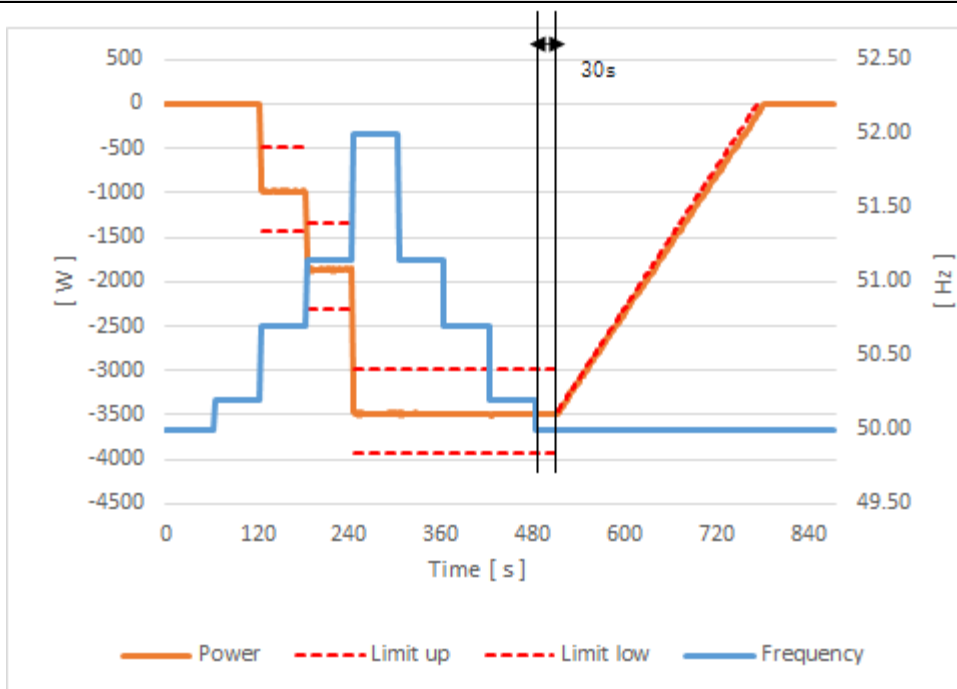

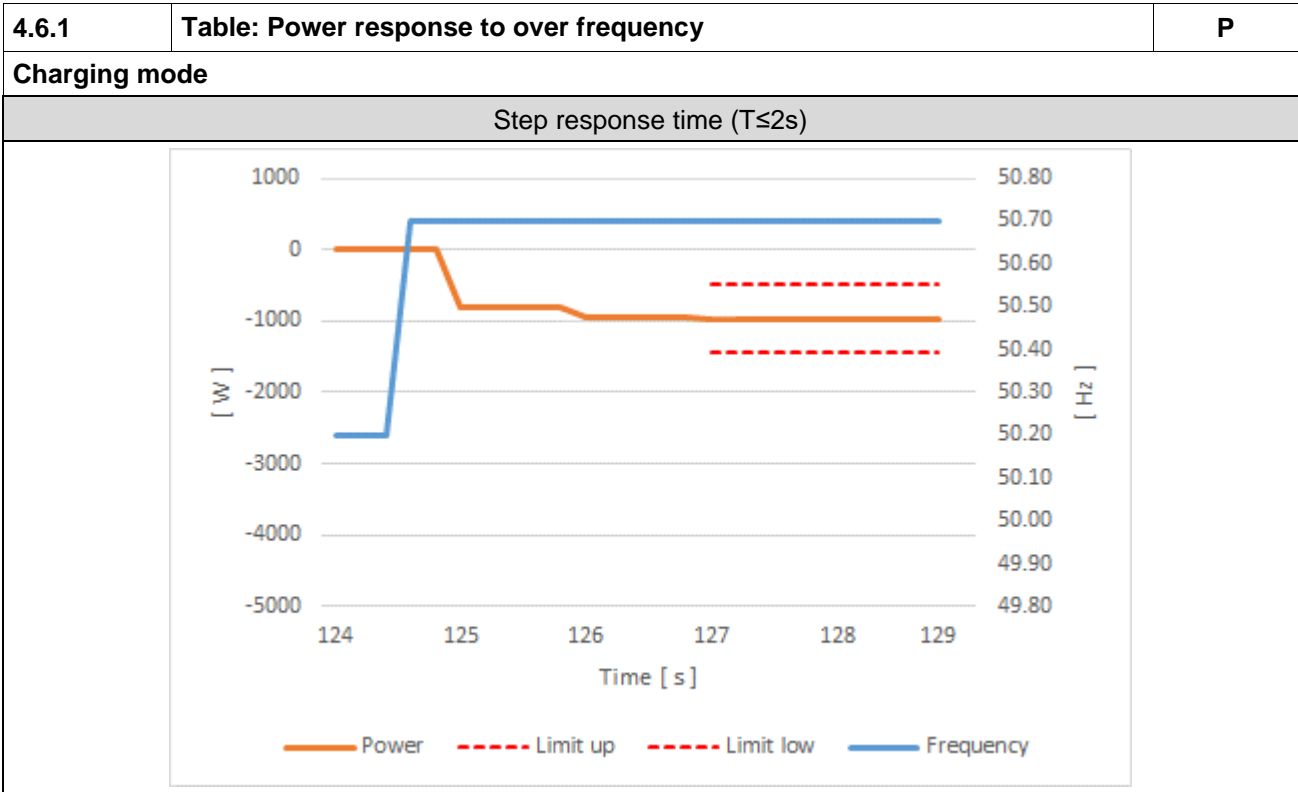

4.6.2	Table: Power response to under frequency						P
Test 1	-100% Pn, f1 =49.8Hz; droop=12%; with delay of 2 s						
	f (Hz)	Measured output Power (W)	Calculated from standard characteristic curve P (W)	Tolerance between measured P and calculated P (W)	Tolerance Limit (W)	For a reduction of active power of 50% Pmax T≤2s	For a reduction of active power T≤20s
	50Hz ± 0.01Hz	50.00	-4831.80	--	--	--	--
	49.8Hz ± 0.01Hz	49.80	-4831.25	-4800.00	-31.25	± 480	--
	49.0Hz ± 0.01z	49.00	-4238.60	-4160.00	-78.60	± 480	1.6s
	48.0Hz ± 0.01z	48.00	-3436.55	-3360.00	-76.55	± 480	0.4s
	47.0Hz ± 0.01z	47.00	-2656.02	-2560.00	-96.02	± 480	0.4s
	46.0Hz ± 0.01z	46.00	-1912.27	-1760.00	-152.27	± 480	0.4s
	47.0Hz ± 0.01z	47.00	-2645.27	-2560.00	-85.27	± 480	0.4s
	48.0Hz ± 0.01z	48.00	-3436.25	-3360.00	-76.25	± 480	0.4s
	49.0Hz ± 0.01z	49.00	-4216.42	-4160.00	-56.42	± 480	0.2s
	49.8Hz ± 0.01Hz	49.80	-4837.38	-4800.00	-37.38	± 480	0.4s
	50.0Hz ± 0.01Hz	50.00	-4843.83	--	--	--	--
Test 2	-100% Pn, f1 =49.8Hz; droop=2%; no delay						
	f (Hz)	Measured output Power (W)	Calculated from standard characteristic curve P (W)	Tolerance between measured P and calculated P (W)	Tolerance Limit (W)	For a reduction of active power of 50% Pmax T≤2s	For a reduction of active power T≤20s
	50Hz ± 0.01Hz	50.00	-4844.86	--	--	--	--
	49.8Hz ± 0.01Hz	49.80	-4811.42	-4800.00	-11.42	± 480	--
	49.0Hz ± 0.01Hz	49.00	-1008.05	-960.00	-48.05	± 480	0.4s
	48.0Hz ± 0.01Hz	48.00	3843.43	3840.00	3.43	± 480	0.6s
	47.0Hz ± 0.01Hz	47.00	4823.47	4800.00	23.47	± 480	0.2s
	46.0Hz ± 0.01Hz	46.00	4810.62	4800.00	10.62	± 480	--
	47.0Hz ± 0.01Hz	47.00	4818.23	4800.00	18.23	± 480	--
	48.0Hz ± 0.01Hz	48.00	3861.55	3840.00	21.55	± 480	0.2s
	49.0Hz ± 0.01Hz	49.00	-968.88	-960.00	-8.88	± 480	0.4s
	49.8Hz ± 0.01Hz	49.80	-4799.95	-4800.00	0.05	± 480	0.4s
	50.0Hz ± 0.01Hz	50.00	-4834.87	--	--	--	--

4.6.2	Table: Power response to under frequency						P
Test 3	-50% Pn, f1 =46.0Hz; droop=5%; no delay						
	f (Hz)	Measured output Power (W)	Calculated from standard characteristic curve P (W)	Tolerance between measured P and calculated P (W)	Tolerance Limit (W)	For a reduction of active power of 50% Pmax T≤2s	For a reduction of active power T≤20s
	50Hz ± 0.01Hz	50.00	-2416.80	--	--	--	--
	49.0Hz ± 0.01Hz	49.00	-2416.18	-2400.00	-16.18	± 480	--
	48.0Hz ± 0.01Hz	48.00	-2416.68	-2400.00	-16.68	± 480	--
	47.0Hz ± 0.01Hz	47.00	-2416.37	-2400.00	-16.37	± 480	--
	46.0Hz ± 0.01Hz	46.00	-2416.28	-2400.00	-16.28	± 480	--
	47.0Hz ± 0.01Hz	47.00	-2416.77	-2400.00	-16.77	± 480	--
	48.0Hz ± 0.01Hz	48.00	-2416.42	-2400.00	-16.42	± 480	--
	49.0Hz ± 0.01Hz	49.00	-2416.78	-2400.00	-16.78	± 480	--
50.0Hz ± 0.01Hz	50.00	-2417.05	--	--	--	--	
Test 4	-50% Pn, f1 =49.8Hz; droop=5%;						
	f (Hz)	Measured output Power (W)	Calculated from standard characteristic curve P (W)	Tolerance between measured P and calculated P (W)	Tolerance Limit (W)	For a reduction of active power of 50% Pmax T≤2s	For a reduction of active power T≤20s
	50Hz ± 0.01Hz	50.00	-2416.18	--	--	--	--
	49.8Hz ± 0.01Hz	49.80	-2397.80	-2400.00	2.20	± 480	--
	49.0Hz ± 0.01Hz	49.00	-881.30	-864.00	-17.30	± 480	0.2s
	48.0Hz ± 0.01Hz	48.00	1099.08	1056.00	43.08	± 480	0.8s
	47.0Hz ± 0.01Hz	47.00	2994.78	2976.00	18.78	± 480	0.2s
	46.0Hz ± 0.01Hz	46.00	4807.50	4800.00	7.50	± 480	0.4s
	47.0Hz ± 0.01Hz	47.00	2954.23	2976.00	-21.77	± 480	0.2s
	48.0Hz ± 0.01Hz	48.00	1055.85	1056.00	-0.15	± 480	0.2s
49.0Hz ± 0.01Hz	49.00	-917.68	-864.00	-53.68	± 480	0.6s	
49.8Hz ± 0.01Hz	49.80	-2415.70	-2400.00	-15.70	± 480	--	
50.0Hz ± 0.01Hz	50.00	-2432.50	--	--	--	--	
Test 1_Graph							

4.6.2	Table: Power response to under frequency	P
Intentional delay time (2s)		
Test 2_Graph		
Step response time($T \leq 2s$)		

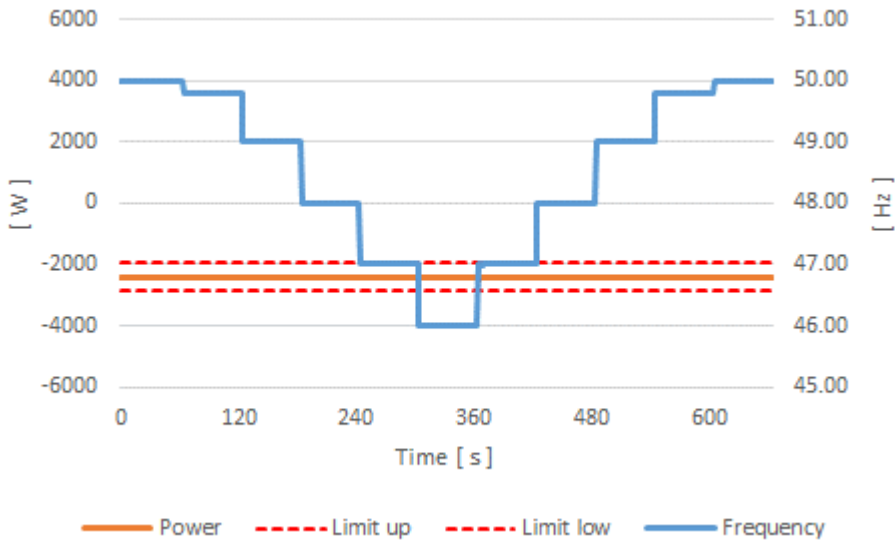
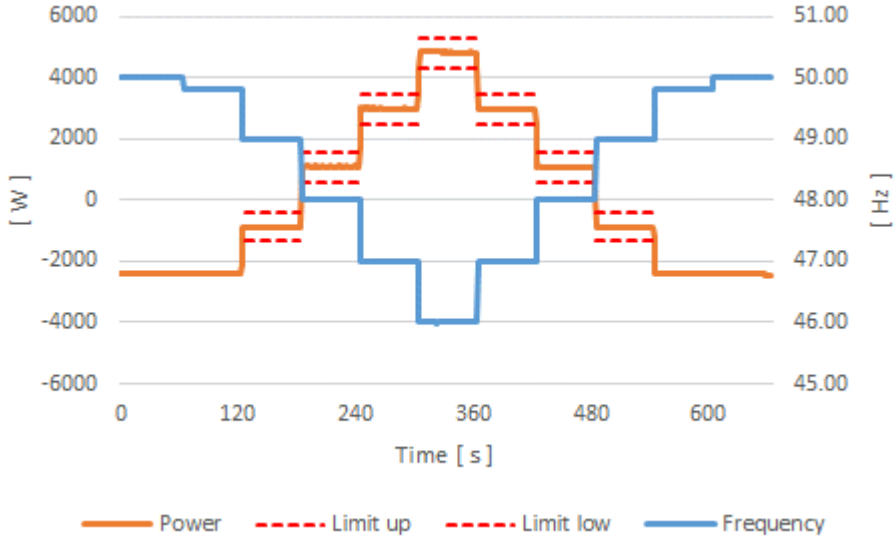
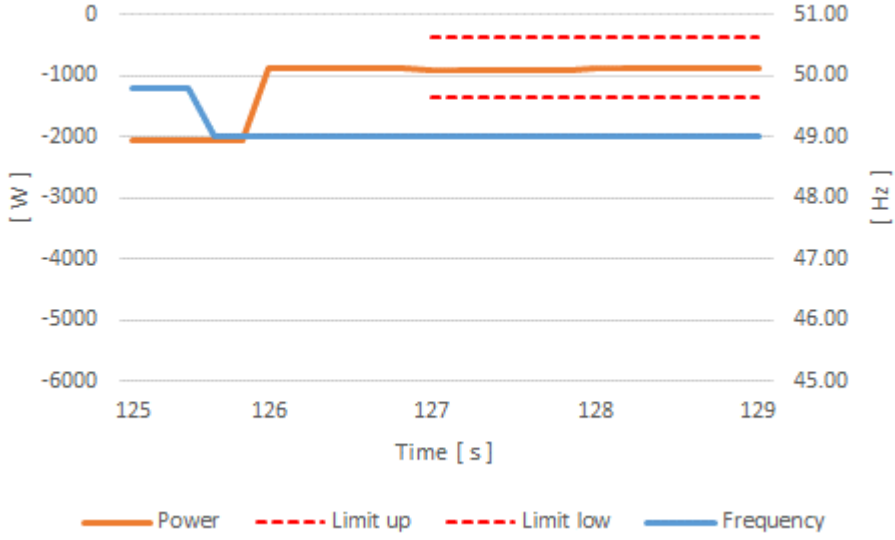
4.6.2	Table: Power response to under frequency	P
Test 3_Graph		
 <p>The graph shows a step-like variation in power and frequency over a 600-second period. Power starts at approximately 4000W, drops to 2000W at 120s, then to -2000W at 240s, reaching a minimum of -4000W at 360s. Frequency starts at 50.00 Hz, drops to 49.00 Hz at 120s, then to 48.00 Hz at 240s, reaching a minimum of 46.00 Hz at 360s. Both parameters return to their initial levels after 480s. Horizontal dashed lines indicate limits at approximately ±2500W for power and 46.50 Hz/47.50 Hz for frequency.</p>		
Test 4_Graph		
 <p>This graph shows a more complex power response. Power starts at -3000W, rises to 1000W at 120s, then to 3000W at 240s, peaking at 5000W between 300s and 360s. Frequency starts at 50.00 Hz, drops to 49.00 Hz at 120s, then to 48.00 Hz at 240s, reaching a minimum of 46.00 Hz at 360s. Both parameters return to their initial levels after 480s. Horizontal dashed lines indicate limits at approximately ±3000W for power and 46.50 Hz/47.50 Hz for frequency.</p>		
Step response time(T≤2s)		
 <p>This zoomed-in view shows the transition between 125s and 129s. At 125s, power is -2000W and frequency is 49.00 Hz. At 126s, power steps up to -1000W and frequency drops to 49.00 Hz. At 127s, power steps up to 0W and frequency drops to 49.00 Hz. At 128s, power steps up to 1000W and frequency drops to 49.00 Hz. At 129s, power steps up to 1000W and frequency drops to 49.00 Hz. Horizontal dashed lines indicate limits at approximately ±1000W for power and 49.00 Hz/49.00 Hz for frequency.</p>		

4.6.2	Table: Power response to under frequency							P
Test 5	-30% Pn, f1 =49.8Hz; droop=12%; with delay of 2 s							
	f (Hz)	Measured output Power (W)	Calculated from standard characteristic curve P (W)	Tolerance between measured P and calculated P (W)	Tolerance Limit (W)	For a reduction of active power of 50% Pmax T≤2s	For a reduction of active power T≤20s	
	50Hz ± 0.01Hz	50.00	-1456.46	--	--	--	--	
	49.8Hz ± 0.01Hz	49.80	-1446.42	-1440.00	-6.42	± 480	--	
	49.0Hz ± 0.01z	49.00	-905.17	-800.00	-105.17	± 480	1.4s	
	48.0Hz ± 0.01z	48.00	-9.90	0.00	-9.90	± 480	0.6s	
	47.0Hz ± 0.01z	47.00	828.00	800.00	28.00	± 480	0.4s	
	46.0Hz ± 0.01z	46.00	1631.87	1600.00	31.87	± 480	0.6s	
	47.0Hz ± 0.01z	47.00	837.42	800.00	37.42	± 480	0.4s	
	48.0Hz ± 0.01z	48.00	-9.97	0.00	-9.97	± 480	0.4s	
	49.0Hz ± 0.01z	49.00	-880.95	-800.00	-80.95	± 480	0.6s	
	49.8Hz ± 0.01Hz	49.80	-1431.80	-1440.00	8.20	± 480	0.4s	
	50.0Hz ± 0.01Hz	50.00	-1432.10	--	--	--	--	
Test 6	-30% Pn, f1 =49.8Hz; droop=2%; no delay							
	f (Hz)	Measured output Power (W)	Calculated from standard characteristic curve P (W)	Tolerance between measured P and calculated P (W)	Tolerance Limit (W)	For a reduction of active power of 50% Pmax T≤2s	For a reduction of active power T≤20s	
	50Hz ± 0.01Hz	50.00	-1443.33	--	--	--	--	
	49.8Hz ± 0.01Hz	49.80	-1455.88	-1440.00	-15.88	± 480	--	
	49.0Hz ± 0.01Hz	49.00	2415.56	2400.00	15.56	± 480	0.2s	
	48.0Hz ± 0.01Hz	48.00	4815.39	4800.00	15.39	± 480	0.4s	
	47.0Hz ± 0.01Hz	47.00	4795.22	4800.00	-4.78	± 480	--	
	46.0Hz ± 0.01Hz	46.00	4818.86	4800.00	18.86	± 480	--	
	47.0Hz ± 0.01Hz	47.00	4816.92	4800.00	16.92	± 480	--	
	48.0Hz ± 0.01Hz	48.00	4816.75	4800.00	16.75	± 480	--	
	49.0Hz ± 0.01Hz	49.00	2449.34	2400.00	49.34	± 480	0.4s	
	49.8Hz ± 0.01Hz	49.80	-1483.08	-1440.00	-43.08	± 480	0.4s	
	50.0Hz ± 0.01Hz	50.00	-1469.23	--	--	--	--	

4.6.2	Table: Power response to under frequency						P
Test 7	-15% Pn, f1 =46.0Hz; droop=5%; no delay						
	f (Hz)	Measured output Power (W)	Calculated from standard characteristic curve P (W)	Tolerance between measured P and calculated P (W)	Tolerance Limit (W)	For a reduction of active power of 50% Pmax T≤2s	For a reduction of active power T≤20s
	50Hz ± 0.01Hz	50.00	-730.59	--	--	--	--
	49.0Hz ± 0.01Hz	49.00	-732.68	-720.00	-12.68	± 480	--
	48.0Hz ± 0.01Hz	48.00	-731.88	-720.00	-11.88	± 480	--
	47.0Hz ± 0.01Hz	47.00	-731.91	-720.00	-11.91	± 480	--
	46.0Hz ± 0.01Hz	46.00	-732.39	-720.00	-12.39	± 480	--
	47.0Hz ± 0.01Hz	47.00	-732.80	-720.00	-12.80	± 480	--
	48.0Hz ± 0.01Hz	48.00	-732.05	-720.00	-12.05	± 480	--
	49.0Hz ± 0.01Hz	49.00	-733.32	-720.00	-13.32	± 480	--
50.0Hz ± 0.01Hz	50.00	-733.54	--	--	--	--	
Test 8	-15% Pn, f1 =49.8Hz; droop=5%;						
	f (Hz)	Measured output Power (W)	Calculated from standard characteristic curve P (W)	Tolerance between measured P and calculated P (W)	Tolerance Limit (W)	For a reduction of active power of 50% Pmax T≤2s	For a reduction of active power T≤20s
	50Hz ± 0.01Hz	50.00	-722.09	--	--	--	--
	49.8Hz ± 0.01Hz	49.80	-710.73	-720.00	9.27	± 480	--
	49.0Hz ± 0.01Hz	49.00	843.90	816.00	27.90	± 480	0.2s
	48.0Hz ± 0.01Hz	48.00	2759.73	2736.00	23.73	± 480	0.4s
	47.0Hz ± 0.01Hz	47.00	4679.92	4656.00	23.92	± 480	0.4s
	46.0Hz ± 0.01Hz	46.00	4830.07	4800.00	30.07	± 480	0.8s
	47.0Hz ± 0.01Hz	47.00	4659.31	4656.00	3.31	± 480	0.6s
	48.0Hz ± 0.01Hz	48.00	2721.68	2736.00	-14.32	± 480	0.6s
49.0Hz ± 0.01Hz	49.00	803.29	816.00	-12.71	± 480	0.4s	
49.8Hz ± 0.01Hz	49.80	-732.28	-720.00	-12.28	± 480	0.6s	
50.0Hz ± 0.01Hz	50.00	-718.48	--	--	--	--	
Test 1_Graph							

4.6.2	Table: Power response to under frequency	P
Intentional delay time (2s)		
Test 2_Graph		
Step response time(T≤2s)		

4.6.2	Table: Power response to under frequency	P
Test 3_Graph		
Test 4_Graph		
Step response time(T≤2s)		

4.7.2.2 Q Capabilities (Power Factor) P

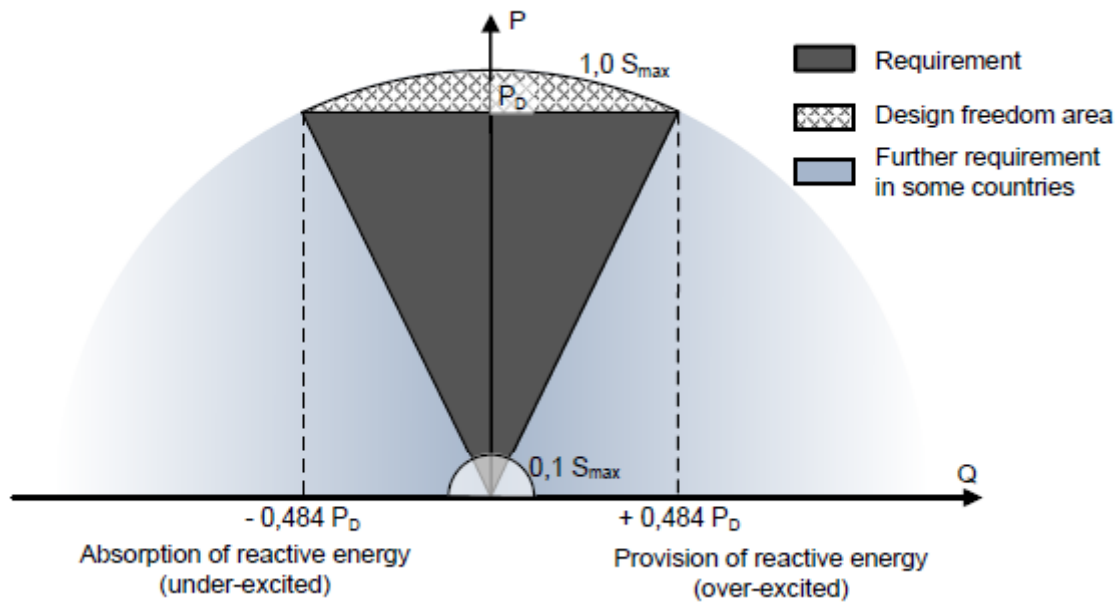

Test result:

Leading PF=0.9:

P/P _n [%] setpoint	P[W]	Q[Var]	Cos φ	Cos φ Set point	Δcos φ	Q[Var] setpoint	ΔQ/S _{max} [%]	LIMITE [%]
10	613.57	368.70	0.8566	0.9	-0.0434	290.59	0.13	± 2
20	1227.15	593.22	0.9000	0.9	0.0000	581.19	0.04	± 2
30	1823.39	884.44	0.8995	0.9	-0.0005	871.78	0.06	± 2
40	2432.61	1186.32	0.8986	0.9	-0.0014	1162.37	0.16	± 2
50	3044.39	1474.92	0.8998	0.9	-0.0002	1452.97	0.18	± 2
60	3656.44	1774.31	0.8996	0.9	-0.0004	1743.56	0.31	± 2
70	4252.45	2063.13	0.8996	0.9	-0.0004	2034.15	0.34	± 2
80	4838.40	2350.41	0.8994	0.9	-0.0006	2324.75	0.34	± 2
90	5456.82	2653.45	0.8992	0.9	-0.0008	2615.34	0.57	± 2
*100	5444.87	2613.24	0.9015	0.9	0.0015	--	--	--

*Remark: Due to the max current limit, the active power can't get to 100%

4.7.2.2 Q Capabilities (Power Factor) **P**

Lagging PF=-0.9:

P/P _n [%] setpoint	P[W]	Q[Var]	Cosφ	Cosφ Set point	Δcosφ	Q[Var] setpoint	ΔQ/S _{max} [%]	LIMITE [%]
10	615.85	-370.49	0.8563	0.9	-0.0437	-290.59	-0.13	± 2
20	1181.75	-574.85	0.8989	0.9	-0.0011	-581.19	0.02	± 2
30	1824.82	-867.72	0.9029	0.9	0.0029	-871.78	0.02	± 2
40	2433.74	-1166.18	0.9017	0.9	0.0017	-1162.37	-0.03	± 2
50	3041.34	-1454.33	0.9020	0.9	0.0020	-1452.97	-0.01	± 2
60	3654.29	-1751.56	0.9017	0.9	0.0017	-1743.56	-0.08	± 2
70	4246.50	-2039.60	0.9013	0.9	0.0013	-2034.15	-0.06	± 2
80	4838.33	-2325.79	0.9012	0.9	0.0012	-2324.75	-0.01	± 2
90	5452.88	-2624.89	0.9010	0.9	0.0010	-2615.34	-0.14	± 2
100	5433.85	-2611.12	0.9013	0.9	0.0013	--	--	--

Q=0:

P/P _n [%] setpoint	P[W]	Q[Var]	Cosφ	Cosφ Set point	Δcosφ	Q[Var] setpoint	ΔQ/S _{max} [%]	LIMITE [%]
10	616.55	67.29	0.9939	1.0	-0.0061	0.00	0.11	± 2
20	1208.93	55.07	0.9989	1.0	-0.0011	0.00	0.18	± 2
30	1832.52	57.13	0.9995	1.0	-0.0005	0.00	0.29	± 2
40	2446.71	66.94	0.9996	1.0	-0.0004	0.00	0.45	± 2
50	3060.10	29.57	0.9997	1.0	-0.0003	0.00	0.25	± 2
60	3673.63	31.05	0.9998	1.0	-0.0002	0.00	0.31	± 2
70	4273.98	-59.16	0.9999	1.0	-0.0001	0.00	-0.69	± 2
80	4864.60	-67.90	0.9999	1.0	-0.0001	0.00	-0.91	± 2
90	5483.36	-76.78	0.9999	1.0	-0.0001	0.00	-1.15	± 2
100	6059.64	-84.92	0.9999	1.0	-0.0001	0.00	-1.42	± 2

Graph

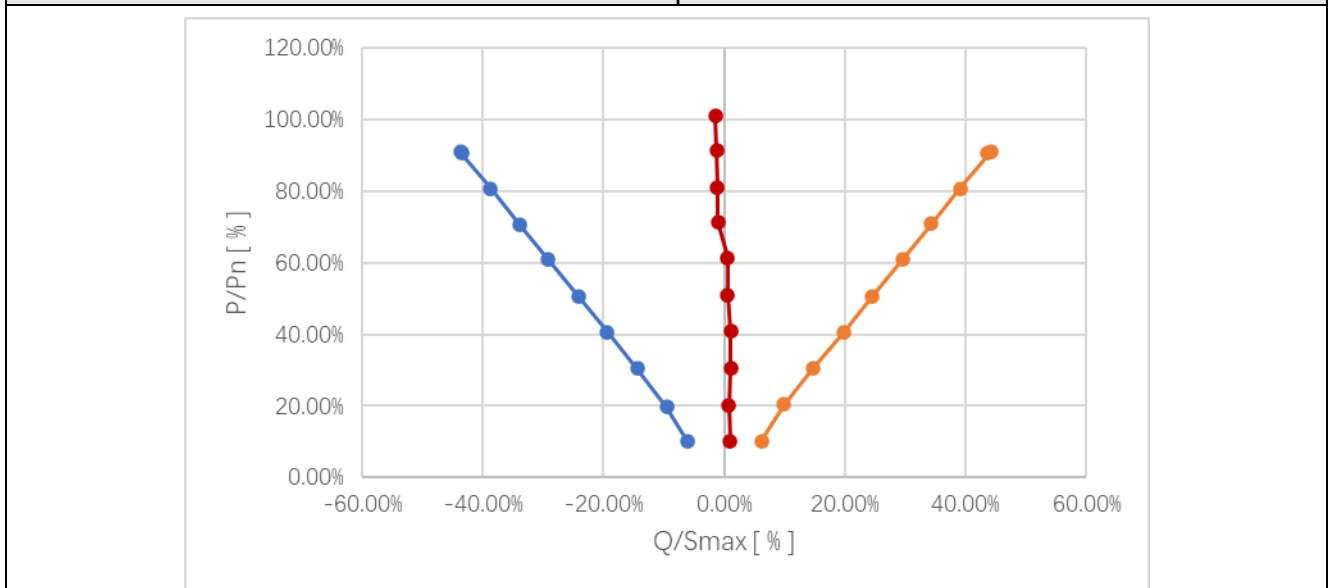

4.7.2.2 Q Capabilities (Power Factor)						P
Q=43.58%Pn						
P/Pn [%] setpoint	P[W]	Q[Var]	Cosφ	Q[Var] setpoint	$\Delta Q/S_{max}$ [%]	LIMITE [%]
10	621.05	2610.17	0.2314	2614.80	-0.08	± 2
20	1219.64	2604.23	0.4240	2614.80	-0.18	± 2
30	1816.10	2602.52	0.5721	2614.80	-0.20	± 2
40	2413.55	2595.52	0.6808	2614.80	-0.32	± 2
50	3016.30	2601.26	0.7572	2614.80	-0.23	± 2
60	3612.44	2622.89	0.8091	2614.80	0.13	± 2
70	4210.93	2609.79	0.8499	2614.80	-0.08	± 2
80	4817.69	2623.26	0.8782	2614.80	0.14	± 2
90	5418.86	2609.98	0.9009	2614.80	-0.08	± 2
100	5419.06	2609.95	0.9009	2614.80	-0.08	± 2
Q=-43.58%Pn						
P/Pn [%] setpoint	P[W]	Q[Var]	Cosφ	Q[Var] setpoint	$\Delta Q/S_{max}$ [%]	LIMITE [%]
10	626.69	-2571.65	0.2366	-2614.80	0.72	± 2
20	1209.51	-2590.00	0.4225	-2614.80	0.41	± 2
30	1809.92	-2600.82	0.5703	-2614.80	0.23	± 2
40	2405.08	-2617.86	0.6766	-2614.80	-0.05	± 2
50	3010.28	-2635.63	0.7528	-2614.80	-0.35	± 2
60	3614.62	-2650.00	0.8068	-2614.80	-0.59	± 2
70	4210.00	-2660.00	0.8453	-2614.80	-0.75	± 2
80	4800.04	-2643.07	0.8760	-2614.80	-0.47	± 2
90	5400.53	-2640.00	0.8987	-2614.80	-0.42	± 2
100*	5401.40	-2610.00	0.9007	-2614.80	0.08	± 2

*Remark: Due to the max current limit, the active power can't get to 100%

Graph

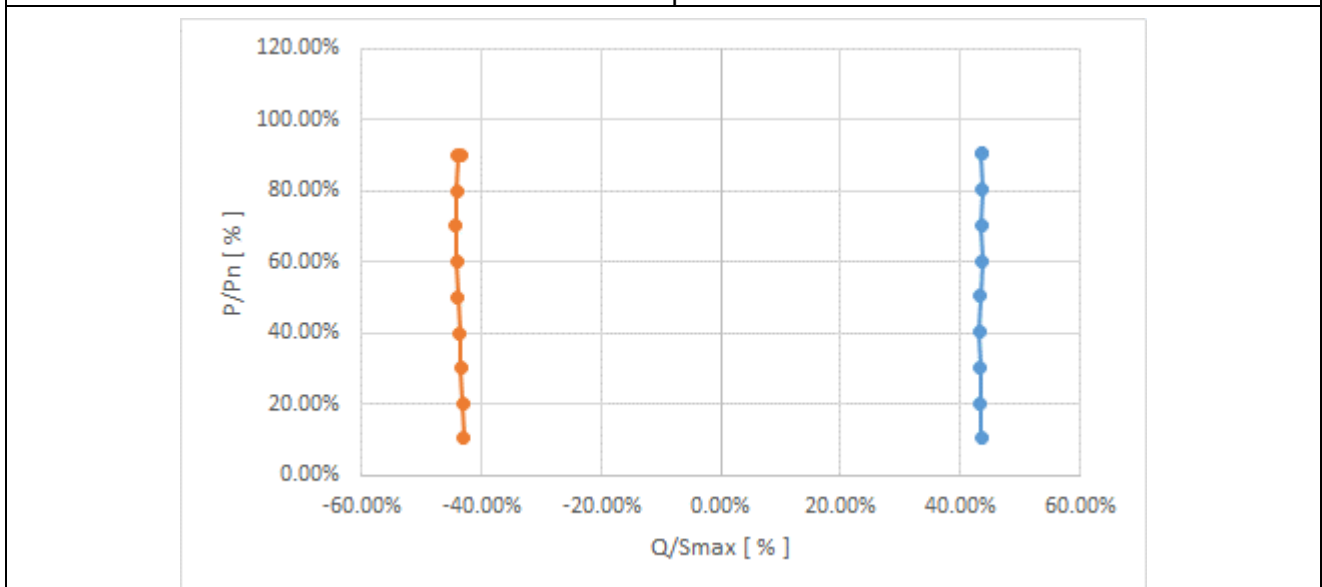
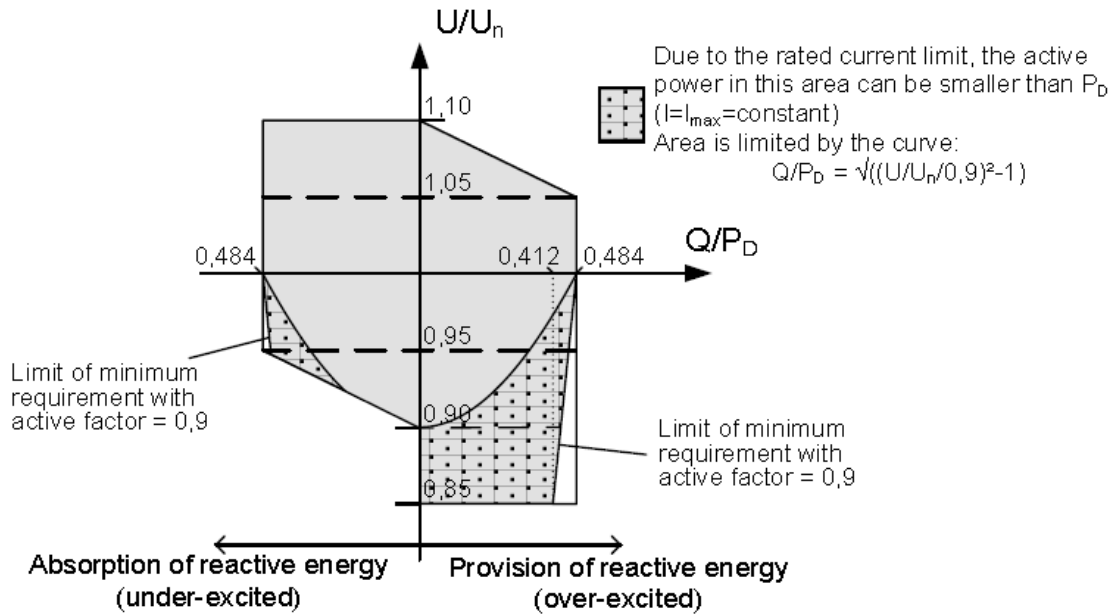

Table 4.7.2.2 Q(U) Capabilities

P



Test result:

Over-excited:

AC output				Reactive power measured		
Voltage setting [V/Vn]	Measured			Reactive power [Var]	Value [Q/P _D]	Limits
	Voltage [V]	[V/Vn]	Active power [W]			
1.10	253.33	1.10	6026.14	-83.97	-0.0139	±0.02
1.08	248.96	1.08	5908.24	1142.96	0.1935	0.194±0.02
1.05	241.93	1.05	5426.82	2608.76	0.4807	0.484±0.02
1.00	230.58	1.00	5426.33	2613.06	0.4816	0.484±0.02
0.95	218.96	0.95	5463.41	2631.23	0.4816	--
0.92	211.74	0.92	5462.95	2624.34	0.4804	--
0.90	207.44	0.90	5463.93	2637.18	0.4827	--
0.85	195.77	0.85	5235.59	2527.39	0.4827	--

Under-excited:

AC output				Reactive power measured		
Voltage setting [V/Vn]	Measured			Reactive power [Var]	Value [Q/P _D]	Limits
	Voltage [V]	[V/Vn]	Active power [W]			
1.10	253.42	1.10	5461.67	-2641.43	-0.4836	-0.484±0.02
1.08	248.81	1.08	5441.30	-2635.28	-0.4843	-0.484±0.02
1.05	241.91	1.05	5403.74	-2608.82	-0.4828	-0.484±0.02
1.00	230.41	1.00	5426.47	-2602.22	-0.4795	-0.484±0.02
0.95	218.82	0.95	5463.93	-2586.13	-0.4733	--
0.92	210.93	0.92	5949.08	-1143.49	-0.1922	-0.194±0.02
0.90	207.31	0.90	6026.62	-83.93	-0.0139	±0.02

4.7.2.3.3 Voltage related control mode Q (U)						P
P/P _n [%] Set-point	Vac [V] Set-point	P/P _n [%] measured	Vac[V] Measured	Q [VAr] measured	Q [Var] expected	Δ Q [Var] (≤ ± 5 % P _n)
< 20 %	1.07 V _n	15.95	246.51	-81.17	≈0 (< ± 5 % P _n)	-1.35
< 20 %	1.09 V _n	16.48	250.99	-82.66	≈0 (< ± 5 % P _n)	-1.38
<20 % → 30 %	1.09 V _n	25.85	251.06	-1314.13	-1307.40 (within 10sec)	-0.11
40 %	1.09 V _n	41.07	251.03	-1322.51	-1307.40	-0.25
50 %	1.09 V _n	51.40	251.09	-1326.20	-1307.40	-0.31
60 %	1.09 V _n	61.43	251.07	-1312.31	-1307.40	-0.08
70 %	1.09 V _n	71.71	251.07	-1310.22	-1307.40	-0.05
80 %	1.09 V _n	80.73	251.03	-1327.99	-1307.40	-0.34
90 %	1.09 V _n	91.08	251.19	-1318.83	-1307.40	-0.19
100 %	1.09 V _n	98.72	251.05	-1309.37	-1307.40	-0.03
100 %	1.10 V _n	90.41	253.35	-2693.60	-2614.80	-1.31
100 % → 10 %	1.10 V _n	10.37	253.39	-2690.70	-2614.80	-1.26
10 % → ≤ 5 %	1.10 V _n	5.05	253.35	-63.15	≈0 (< ± 5 % P _n)	-1.05
Remark: V1 _s = 1.08 V _n . V2 _s = 1.1 V _n . V1 _i = 0.92 V _n . V2 _i = 0.9 V _n . lock-in value P = 0.2P _n . lock-out value P = 0.05P _n .						
P/P _n [%] Set-point	Vac [V] Set-point	P/P _n [%] measured	Vac [V] Measured	Q [VAr] measured	Q [Var] expected	Δ Q [Var] (≤ ± 5 % P _n)
< 20 %	0.93 V _n	15.07	213.92	60.01	≈0 (< ± 5 % P _n)	1.00
< 20 %	0.91 V _n	15.11	209.34	62.36	≈0 (< ± 5 % P _n)	1.04
<20 % → 30 %	0.91 V _n	25.65	209.24	1221.68	1307.40 (within 10sec)	-1.43
40 %	0.91 V _n	40.57	209.40	1274.79	1307.40	-0.54
50 %	0.91 V _n	50.08	209.35	1288.11	1307.40	-0.32
60 %	0.91 V _n	60.66	209.33	1292.69	1307.40	-0.25
70 %	0.91 V _n	71.00	209.33	1269.33	1307.40	-0.63
80 %	0.91 V _n	80.11	209.39	1277.21	1307.40	-0.50
90 %	0.91 V _n	90.53	209.38	1295.42	1307.40	-0.20
100 %	0.91 V _n	98.19	209.39	1303.32	1307.40	-0.07
100 %	0.90 V _n	91.61	206.68	2604.76	2614.80	-0.17
100 % → 10 %	0.90 V _n	11.15	206.42	2611.23	2614.80	-0.06
10 % → ≤ 5 %	0.91 V _n	4.79	206.56	81.75	≈0 (< ± 5 % P _n)	1.36
Remark: V1 _s = 1.08 V _n . V2 _s = 1.1 V _n . V1 _i = 0.92 V _n . V2 _i = 0.9 V _n . lock-in value P = 0.2P _n . lock-out value P = 0.05P _n .						

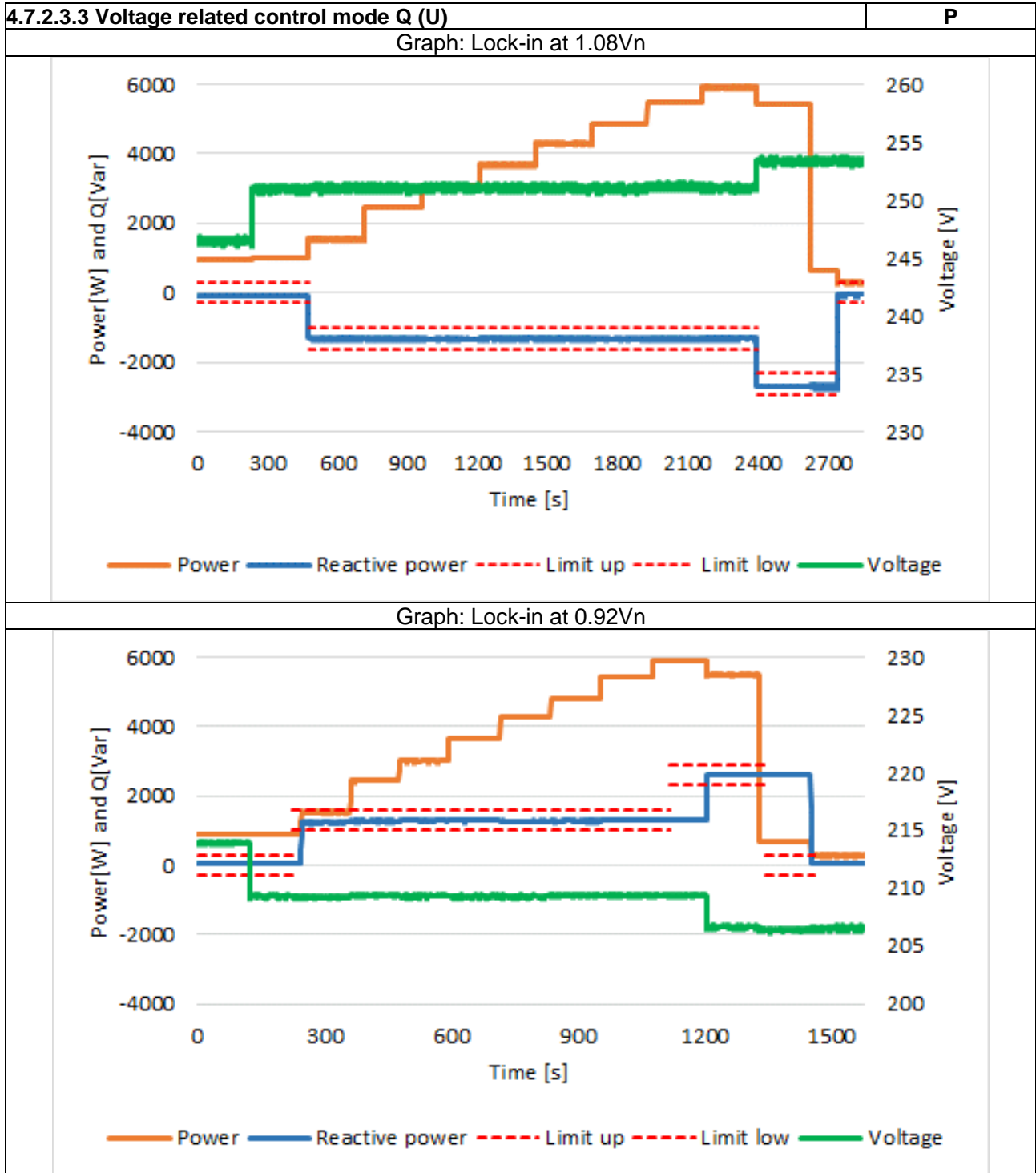

4.7.2.3.4 Power related control modes

P Desired (%Sn)	P measured (%Sn)	Q measured (Var)	Voltage Desired (%Un)	Voltage Measured (%Un)	Power Factor desired (cos φ)	Power Factor measured (cos φ)	ΔQ (%S _{Max})	Limit (%S _{Max})
20%	20.60	-70.19	<105%	103.87	1.0000	0.9983	-1.17	±2
30%	30.49	-63.42	<105%	103.83	1.0000	0.9994	-1.06	±2
40%	40.45	-75.38	<105%	103.73	1.0000	0.9995	-1.26	±2
50%	50.64	-85.43	<105%	103.78	1.0000	0.9996	-1.42	±2
60%	61.04	-98.54	<105%	104.01	1.0000	0.9996	-1.64	±2
60%	61.07	-715.69	>105%	106.01	0.9800	0.9814	0.26	±2
70%	70.50	-1216.04	>105%	106.13	0.9600	0.9610	0.15	±2
80%	80.70	-1711.15	>105%	106.21	0.9400	0.9428	0.52	±2
90%	90.37	-2295.71	>105%	106.34	0.9200	0.9208	0.08	±2
100%	90.94	-2639.49	>105%	106.42	0.9000	0.9001	-0.42	±2
100%	100.43	-94.56	<100%	100.10	1.0000	0.9998	-1.58	±2

Remark: Tested at lock-in voltage 1.05 Vn and lock-out voltage Vn.

The Lock-in value is adjustable between Vn and 1.1Vn in 0.01V steps, the Lock-out value is adjustable between 0.9Vn and Vn in 0.01V steps

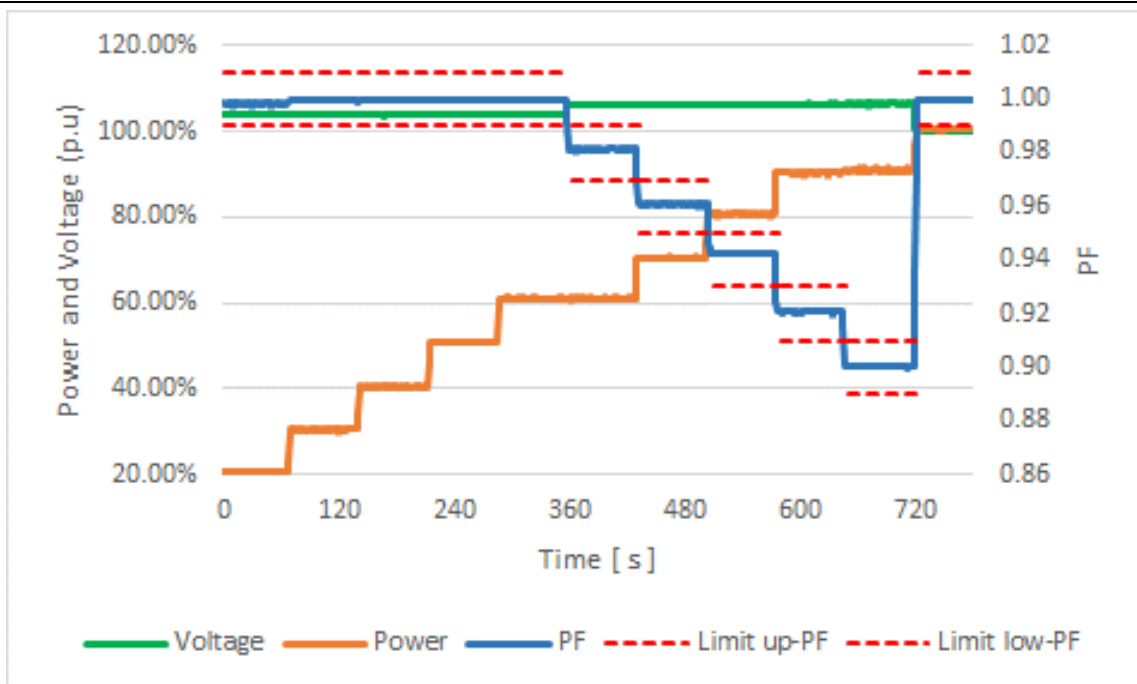

4.7.3 Voltage related active power reduction P(U)

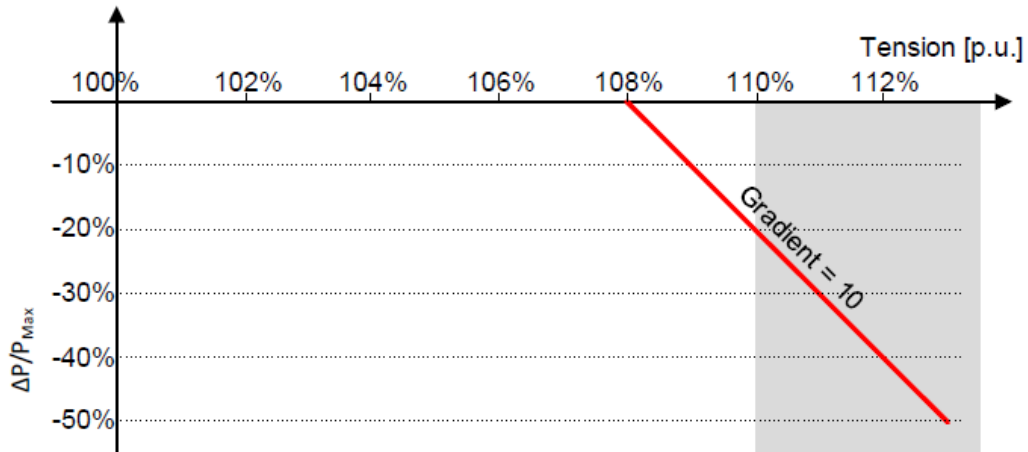

Step #	Set voltage vaule V/Vn [%]	Measured voltage vaule V/Vn [%]	Measured power values [W]	Measured power bin [%]	Limit [%]
1	100	100.01	6019.76	100.19	--
2	110	110.01	4512.47	75.21	--
3	113	113.01	2255.30	37.59	<50

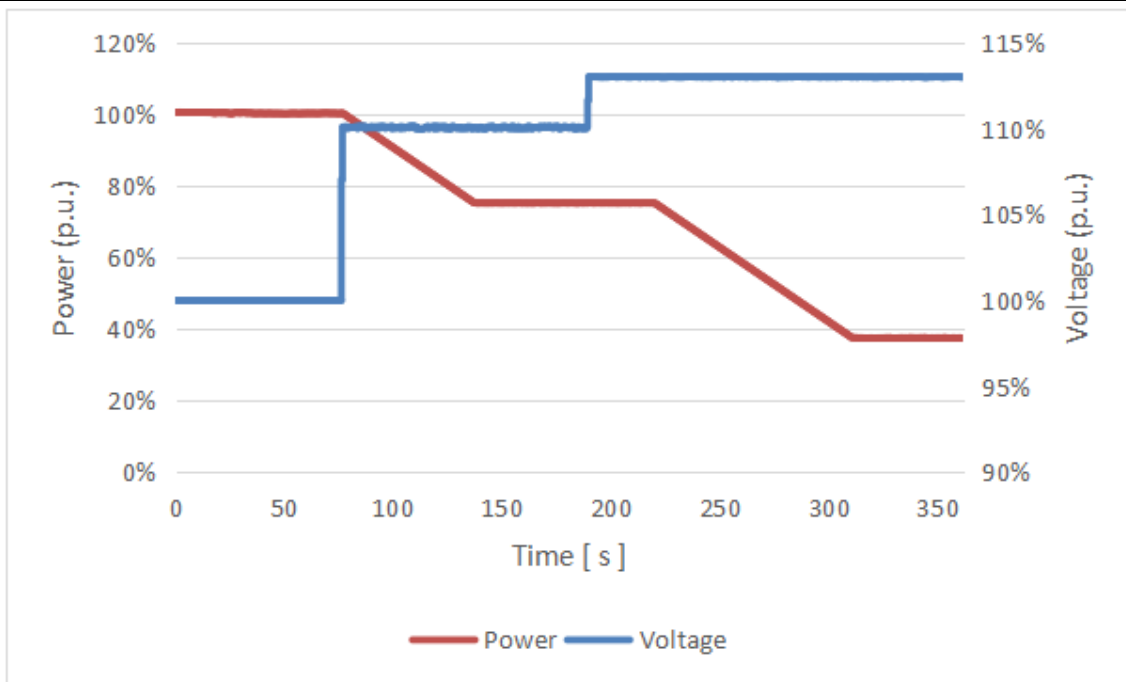

TABLE: Flick						P																																																																																										
Model: AF1k-SL-1																																																																																																
Value	Dc (%)	Dmax (%)	d(t) – 500ms	P _{st}	P _{It}																																																																																											
Limit	3.30	4.00	3.30%	1.00	0.65																																																																																											
Test value	L1	0.24	0.71	0	0.17																																																																																											
	L2	---	---	---	---																																																																																											
	L3	---	---	---	---																																																																																											
<p>Flicker Mode Uover: ■■■■ YOKOGAWA Iover: ■■■■ Flicker: Complete 2:00:00</p> <p>Count 12/12 Interval 10m00s/10m00s</p> <p>Element 3 Volt Range 300V/50Hz Element3 Judgement: Pass Un (U3) 230.607 V Total Judgement: Pass Freq(U3) 50.015 Hz (Element3)</p> <table border="1"> <thead> <tr> <th></th> <th>dc[%]</th> <th>dmax[%]</th> <th>d(t)[ms]</th> <th>Pst</th> <th>PIt</th> </tr> </thead> <tbody> <tr> <td>Limit</td> <td>3.30</td> <td>4.00</td> <td>500 3.30(%)</td> <td>1.00</td> <td>0.65 N: 12</td> </tr> <tr> <td>No. 1</td> <td>0.16 Pass</td> <td>0.53 Pass</td> <td>0 Pass</td> <td>0.18 Pass</td> <td></td> </tr> <tr> <td>2</td> <td>0.20 Pass</td> <td>0.71 Pass</td> <td>0 Pass</td> <td>0.17 Pass</td> <td></td> </tr> <tr> <td>3</td> <td>0.18 Pass</td> <td>0.51 Pass</td> <td>0 Pass</td> <td>0.16 Pass</td> <td></td> </tr> <tr> <td>4</td> <td>0.19 Pass</td> <td>0.66 Pass</td> <td>0 Pass</td> <td>0.19 Pass</td> <td></td> </tr> <tr> <td>5</td> <td>0.15 Pass</td> <td>0.57 Pass</td> <td>0 Pass</td> <td>0.16 Pass</td> <td></td> </tr> <tr> <td>6</td> <td>0.14 Pass</td> <td>0.50 Pass</td> <td>0 Pass</td> <td>0.15 Pass</td> <td></td> </tr> <tr> <td>7</td> <td>0.19 Pass</td> <td>0.52 Pass</td> <td>0 Pass</td> <td>0.17 Pass</td> <td></td> </tr> <tr> <td>8</td> <td>0.18 Pass</td> <td>0.54 Pass</td> <td>0 Pass</td> <td>0.17 Pass</td> <td></td> </tr> <tr> <td>9</td> <td>0.19 Pass</td> <td>0.61 Pass</td> <td>0 Pass</td> <td>0.16 Pass</td> <td></td> </tr> <tr> <td>10</td> <td>0.17 Pass</td> <td>0.53 Pass</td> <td>0 Pass</td> <td>0.17 Pass</td> <td></td> </tr> <tr> <td>11</td> <td>0.24 Pass</td> <td>0.55 Pass</td> <td>0 Pass</td> <td>0.15 Pass</td> <td></td> </tr> <tr> <td>12</td> <td>0.18 Pass</td> <td>0.62 Pass</td> <td>0 Pass</td> <td>0.17 Pass</td> <td></td> </tr> <tr> <td>Result</td> <td>Pass</td> <td>Pass</td> <td>Pass</td> <td>Pass</td> <td>0.17 Pass</td> </tr> </tbody> </table> <p>Update 3600</p>								dc[%]	dmax[%]	d(t)[ms]	Pst	PIt	Limit	3.30	4.00	500 3.30(%)	1.00	0.65 N: 12	No. 1	0.16 Pass	0.53 Pass	0 Pass	0.18 Pass		2	0.20 Pass	0.71 Pass	0 Pass	0.17 Pass		3	0.18 Pass	0.51 Pass	0 Pass	0.16 Pass		4	0.19 Pass	0.66 Pass	0 Pass	0.19 Pass		5	0.15 Pass	0.57 Pass	0 Pass	0.16 Pass		6	0.14 Pass	0.50 Pass	0 Pass	0.15 Pass		7	0.19 Pass	0.52 Pass	0 Pass	0.17 Pass		8	0.18 Pass	0.54 Pass	0 Pass	0.17 Pass		9	0.19 Pass	0.61 Pass	0 Pass	0.16 Pass		10	0.17 Pass	0.53 Pass	0 Pass	0.17 Pass		11	0.24 Pass	0.55 Pass	0 Pass	0.15 Pass		12	0.18 Pass	0.62 Pass	0 Pass	0.17 Pass		Result	Pass	Pass	Pass	Pass	0.17 Pass
	dc[%]	dmax[%]	d(t)[ms]	Pst	PIt																																																																																											
Limit	3.30	4.00	500 3.30(%)	1.00	0.65 N: 12																																																																																											
No. 1	0.16 Pass	0.53 Pass	0 Pass	0.18 Pass																																																																																												
2	0.20 Pass	0.71 Pass	0 Pass	0.17 Pass																																																																																												
3	0.18 Pass	0.51 Pass	0 Pass	0.16 Pass																																																																																												
4	0.19 Pass	0.66 Pass	0 Pass	0.19 Pass																																																																																												
5	0.15 Pass	0.57 Pass	0 Pass	0.16 Pass																																																																																												
6	0.14 Pass	0.50 Pass	0 Pass	0.15 Pass																																																																																												
7	0.19 Pass	0.52 Pass	0 Pass	0.17 Pass																																																																																												
8	0.18 Pass	0.54 Pass	0 Pass	0.17 Pass																																																																																												
9	0.19 Pass	0.61 Pass	0 Pass	0.16 Pass																																																																																												
10	0.17 Pass	0.53 Pass	0 Pass	0.17 Pass																																																																																												
11	0.24 Pass	0.55 Pass	0 Pass	0.15 Pass																																																																																												
12	0.18 Pass	0.62 Pass	0 Pass	0.17 Pass																																																																																												
Result	Pass	Pass	Pass	Pass	0.17 Pass																																																																																											
L1 phase																																																																																																

4.8	Table: Harmonic current emissions			AF6k-SL
Hamonics order n	Measured Value (%)			Limit in BS EN 61000-3-12 (%)
	33%	66%	100%	
2	0.28	0.29	0.33	8%
3	0.83	0.93	1.41	21.6%
4	0.04	0.07	0.09	4%
5	0.50	0.53	0.62	10.7%
6	0.04	0.02	0.02	2.67%
7	0.43	0.49	0.59	7.2%
8	0.05	0.02	0.02	2%
9	0.34	0.41	0.46	3.8%
10	0.03	0.03	0.03	1.6%
11	0.19	0.29	0.34	3.1%
12	0.05	0.02	0.02	1.33%
13	0.17	0.24	0.28	2%
14	0.05	0.02	0.02	N/A
15	0.14	0.16	0.19	N/A
16	0.04	0.02	0.03	N/A
17	0.11	0.15	0.15	N/A
18	0.04	0.03	0.02	N/A
19	0.06	0.11	0.10	N/A
20	0.02	0.03	0.02	N/A
21	0.05	0.08	0.07	N/A
22	0.02	0.03	0.02	N/A
23	0.03	0.06	0.05	N/A
24	0.02	0.03	0.03	N/A
25	0.02	0.05	0.06	N/A
26	0.02	0.02	0.02	N/A
27	0.03	0.03	0.04	N/A
28	0.01	0.02	0.02	N/A
29	0.02	0.04	0.04	N/A
30	0.01	0.02	0.03	N/A
31	0.02	0.04	0.04	N/A
32	0.02	0.02	0.02	N/A
33	0.02	0.03	0.02	N/A
34	0.01	0.02	0.02	N/A
35	0.02	0.02	0.02	N/A
36	0.02	0.02	0.03	N/A
37	0.01	0.02	0.02	N/A
38	0.01	0.02	0.02	N/A
39	0.01	0.02	0.03	N/A
40	0.01	0.01	0.02	N/A
THD	1.17	1.38	1.84	13%
PWHD	0.95	1.30	1.34	22%

4.8	Table: Harmonic current emissions			AF1k-SL-1
Hamonics order n	Measured Value (A)			Limit in BS EN 61000-3-2 in Amps
	33%	66%	100%	
2	0.083	0.089	0.101	1.080
3	0.266	0.242	0.246	2.300
4	0.028	0.025	0.028	0.430
5	0.132	0.134	0.139	1.140
6	0.021	0.012	0.007	0.300
7	0.093	0.116	0.118	0.770
8	0.009	0.012	0.005	0.230
9	0.038	0.090	0.097	0.400
10	0.009	0.007	0.005	0.184
11	0.023	0.054	0.074	0.330
12	0.006	0.010	0.011	0.153
13	0.009	0.047	0.065	0.210
14	0.009	0.015	0.012	0.131
15	0.018	0.040	0.045	0.150
16	0.007	0.011	0.009	0.115
17	0.022	0.030	0.034	0.132
18	0.009	0.012	0.008	0.102
19	0.019	0.016	0.021	0.118
20	0.005	0.003	0.004	0.092
21	0.016	0.012	0.020	0.107
22	0.005	0.004	0.007	0.084
23	0.014	0.010	0.016	0.098
24	0.006	0.003	0.010	0.077
25	0.005	0.005	0.016	0.090
26	0.004	0.003	0.007	0.071
27	0.008	0.007	0.008	0.083
28	0.004	0.003	0.003	0.066
29	0.006	0.005	0.007	0.078
30	0.005	0.003	0.003	0.061
31	0.007	0.004	0.006	0.073
32	0.003	0.003	0.004	0.058
33	0.008	0.003	0.008	0.068
34	0.003	0.002	0.004	0.054
35	0.008	0.004	0.008	0.064
36	0.005	0.006	0.007	0.051
37	0.007	0.003	0.007	0.061
38	0.002	0.003	0.004	0.048
39	0.005	0.003	0.007	0.058
40	0.003	0.003	0.004	0.046
THD	2.402	2.538	2.778	5%

Table 4.9.3 Interface protection					P
Undervoltage threshold stage 1 [27 <] Adjustment range				Yes	No
Trip value Config. from 0.2 to 1 Un (0.01 Un steps)				Yes	
Trip time Config. from 0.1 to 100 s (0.1 s steps)				Yes	
Parameter	Settings	Test 1	Test 2	Test 3	Limits
Trip value L1[V]	46	45.64	45.84	45.31	46±2.3
Trip time [ms]	100	98.40	99.20	99.40	100±10
L2 [V]					46±2.3
Trip time [ms]					100±10
L3 [V]					46±2.3
Trip time [ms]					100±10
L1L2L3[V]					46±2.3
Trip time [ms]					100±10
Parameter	Settings	Test 1	Test 2	Test 3	Limits
Trip value L1[V]	46	44.73	45.46	45.22	46±2.3
Trip time [s]	100	100.00	99.98	99.99	100±10
L2 [V]					46±2.3
Trip time [s]					100±10
L3 [V]					46±2.3
Trip time [s]					100±10
L1L2L3[V]					46±2.3
Trip time [s]					100±10

Trip time (0.1s setting)

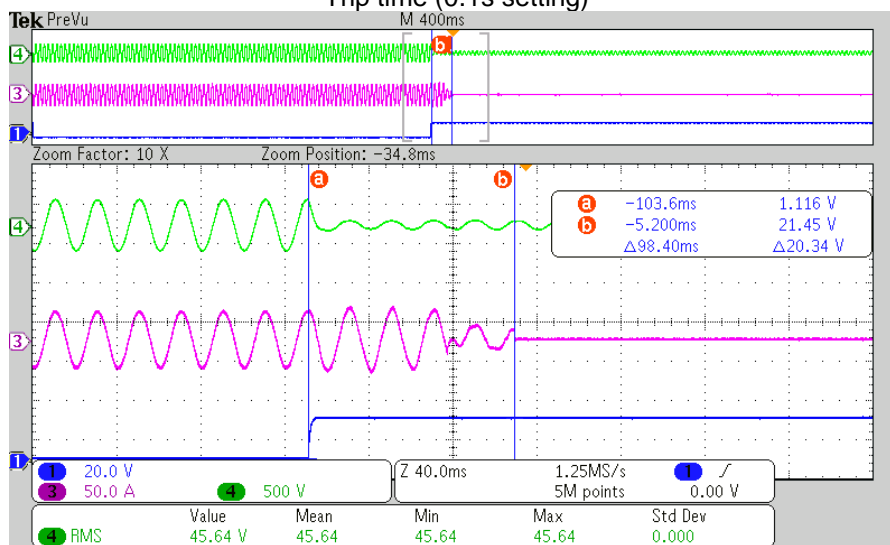

Trip time (100s setting)

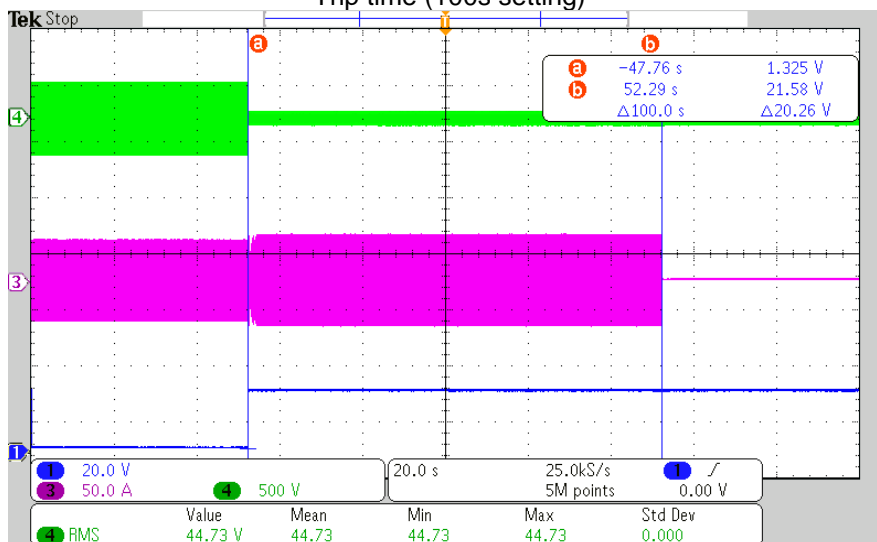
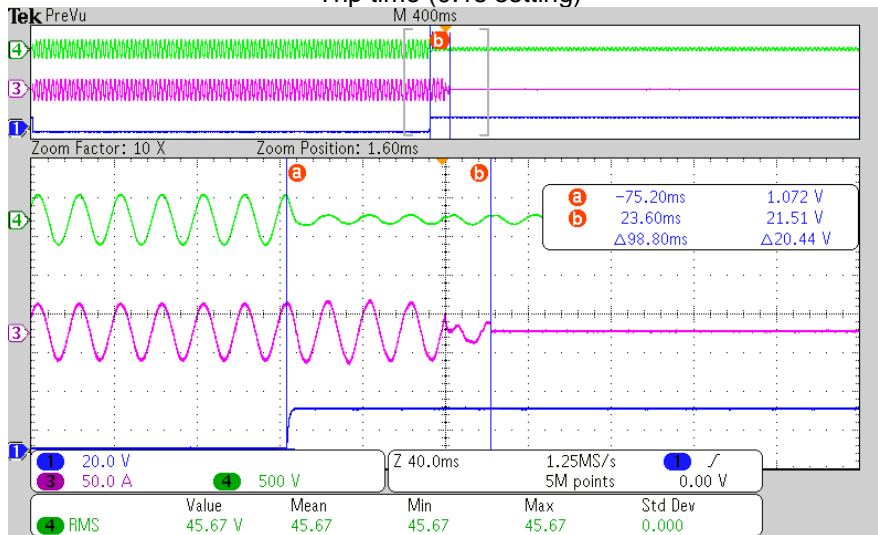

Table 4.9.3 Interface protection					P
Undervoltage threshold stage 2 [27 <] Adjustment range				Yes	No
Trip value Config. from 0.2 to 1 Un (0.01 Un steps)				Yes	
Trip time Config. from 0.1 to 5s (0.05 s steps)				Yes	
Parameter	Settings	Test 1	Test 2	Test 3	Limits
Trip value L1 [V]	46	45.67	45.18	45.96	46±2.3
Trip time [ms]	100	98.80	96.97	97.64	100±10
L2 [V]					46±2.3
Trip time [ms]					100±10
L3 [V]					46±2.3
Trip time [ms]					100±10
L1L2L3[V]					46±2.3
Trip time [ms]					100±10
Parameter	Settings	Test 1	Test 2	Test 3	Limits
Trip value L1 [V]	46	45.58	44.79	44.86	46±2.3
Trip time [s]	5	4.985	4.990	4.982	5±0.05
L2 [V]					46±2.3
Trip time [s]					5±0.05
L3 [V]					46±2.3
Trip time [s]					5±0.05
L1L2L3[V]					46±2.3
Trip time [s]					5±0.05

Trip time (0.1s setting)



Trip time (5s setting)

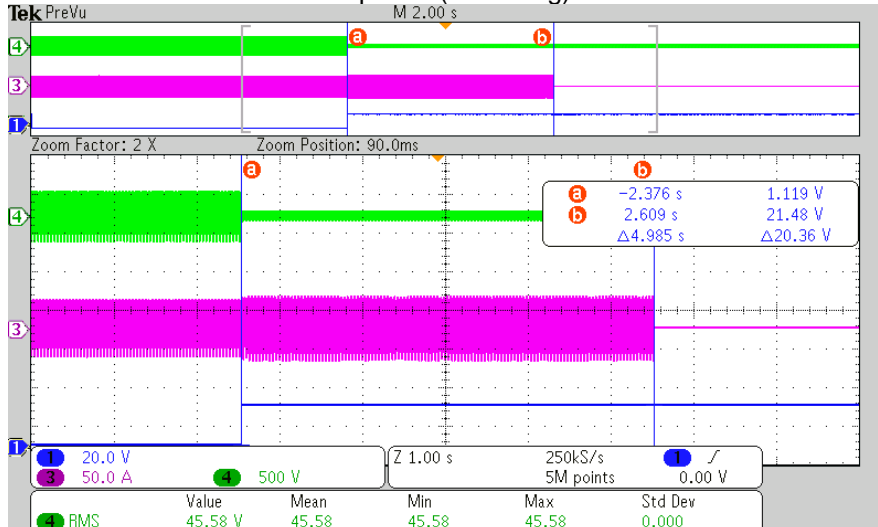
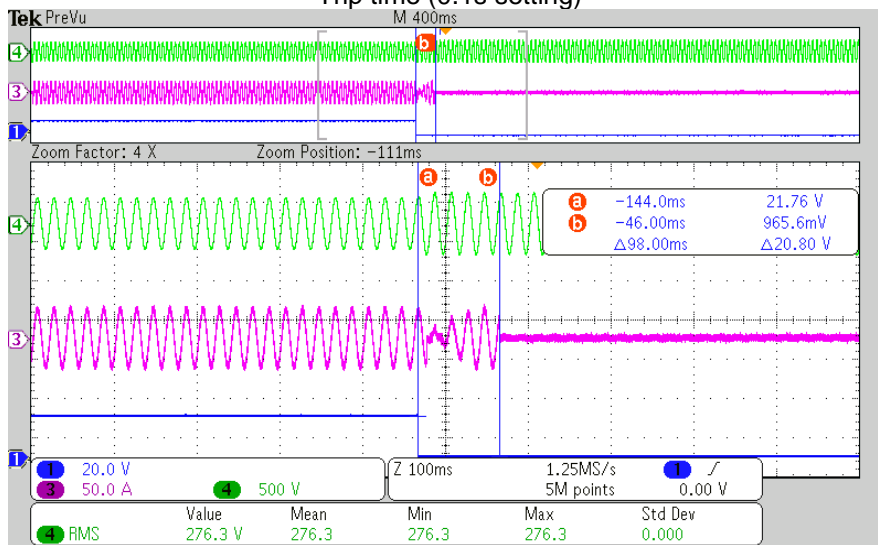

Table 4.9.3 Interface protection					P
Overvoltage threshold stage 1 [59 >] Adjustment range				Yes	No
Trip value Config. from 1.0 to 1.2 Un (0.01 Un steps)				Yes	
Trip time Config. from 0.1 to 100s (0.1 s steps)				Yes	
Parameter	Settings	Test 1	Test 2	Test 3	Limits
Trip value L1 [V]	276	276.3	276.4	277.3	276±2.3
Trip time [ms]	100	98.00	97.85	97.23	100±10
L2 [V]					
Trip time [ms]					
L3 [V]					
Trip time [ms]					
L1L2L3[V]					
Trip time [ms]					
Parameter	Settings	Test 1	Test 2	Test 3	Limits
Trip value L1 [V]	276	277.3	276.5	277.4	276±2.3
Trip time [s]	100	100.00	100.00	100.00	100±10
L2 [V]					
Trip time [s]					
L3 [V]					
Trip time [s]					
L1L2L3[V]					
Trip time [s]					

Trip time (0.1s setting)



Trip time (100s setting)

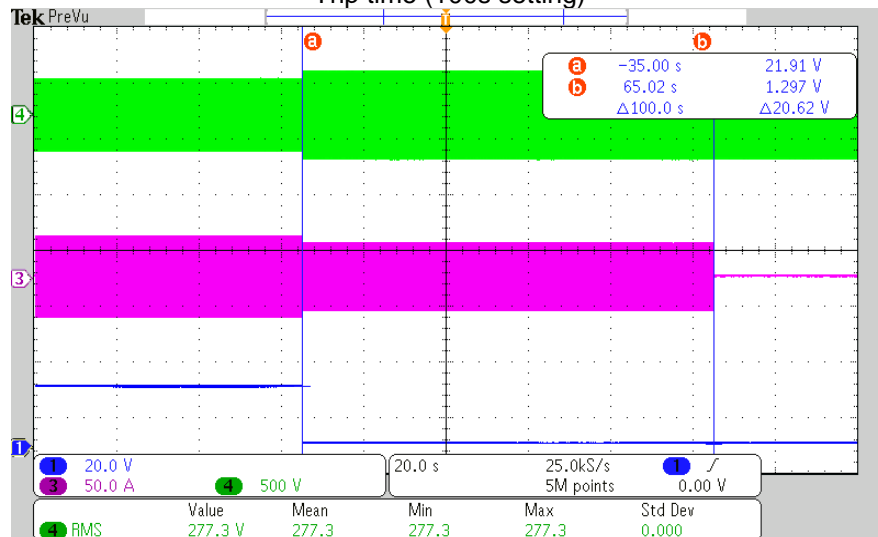
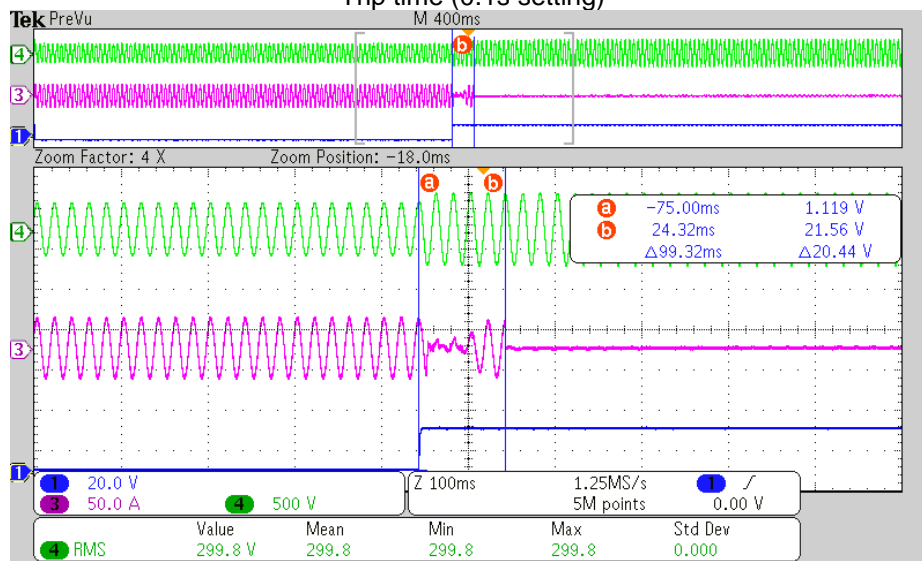

Table 4.9.3 Interface protection					P
Overvoltage threshold stage 2 [59 > >] Adjustment range				Yes	No
Trip value Config. from 1.0 to 1.3 Un (0.01 Un steps)				Yes	
Trip time Config. from 0.1 to 5s (0.05s steps)				Yes	
Parameter	Settings	Test 1	Test 2	Test 3	Limits
Trip value L1 [V]	299	299.8	299.60	299.20	299±2.3
Trip time [ms]	100	99.32	97.64	98.27	100±10
L2 [V]					
Trip time [ms]					
L3 [V]					
Trip time [ms]					
L1L2L3[V]					
Trip time [ms]					
Parameter	Settings	Test 1	Test 2	Test 3	Limits
Trip value L1 [V]	299	300.7	300.3	299.8	299±2.3
Trip time [s]	5	4.985	4.992	4.996	5±0.05
L2 [V]					
Trip time [s]					
L3 [V]					
Trip time [ms]					
L1L2L3[V]					
Trip time [s]					

Trip time (0.1s setting)



Trip time (5s setting)

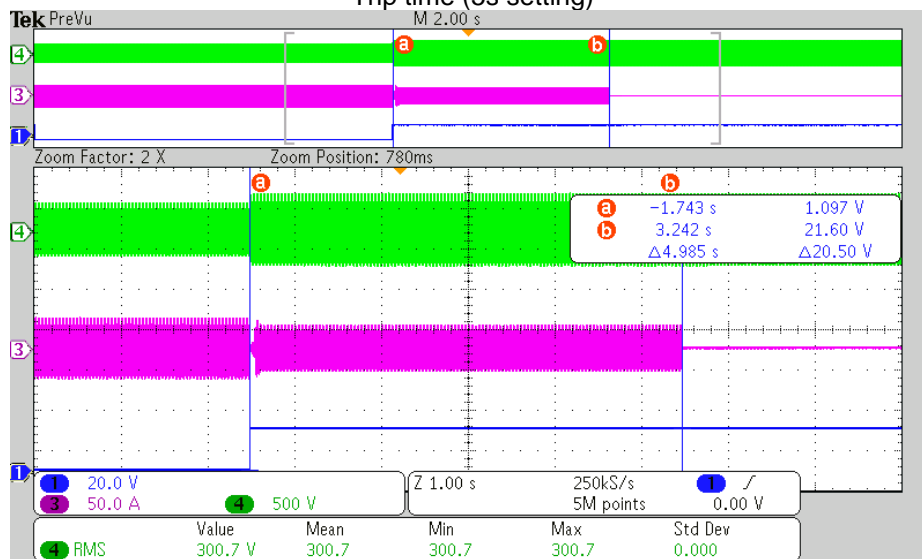

Table 4.9.3 Interface protection					P
Overvoltage 10 min mean protection Adjustment range			Yes	No	
Trip value Config. from 1.0 to 1.15Un (0.01 Un steps)			Yes	--	
Trip time Config $\leq 3s$ not adjustable Time delay setting = 0 ms			Yes	--	
Parameter	Settings	Test 1	Test 2	Test 3	Limits
Trip value L1 [V]	253	253.03	253.06	253.04	253 \pm 1%
Trip time [s]	< 603s	403.2	401.4	402.2	$\leq 603s$
L2 [V]					
Trip time [s]					
L3 [V]					
Trip time [s]					
L1L2L3[V]					
Trip time [s]					

Graph_L1

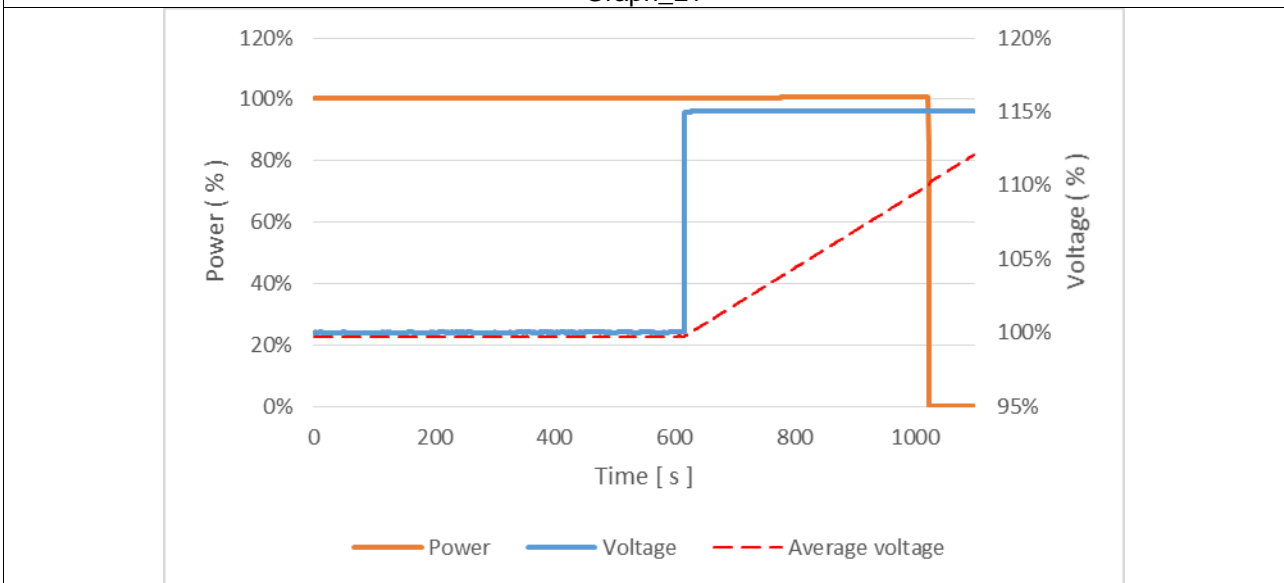
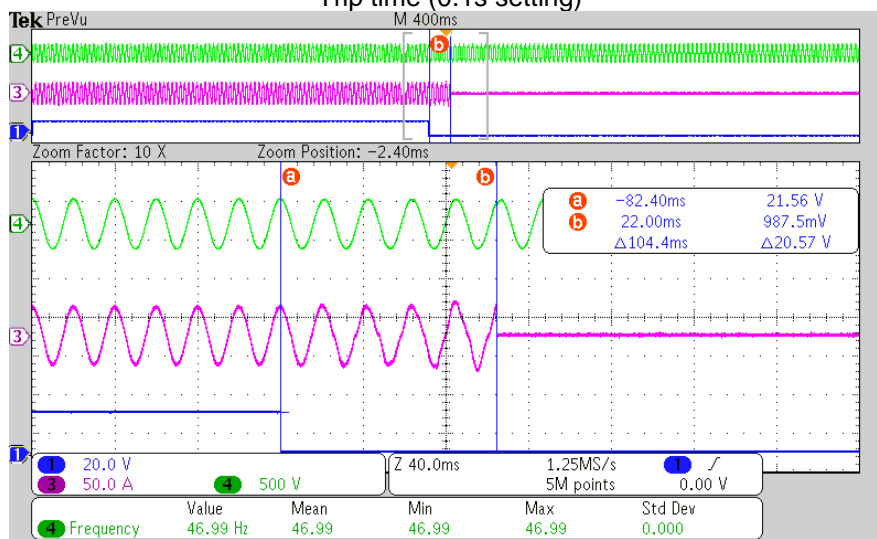

Table 4.9.3 Interface protection					P
Underfrequency threshold stage 1 [81 <] Adjustment range				Yes	No
Trip value Config. from 47.0 to 50.0Hz (0.1Hz steps)				Yes	--
Trip time Config. from 0.1 to 100s (0.1s steps)				Yes	--
it may be required to have the ability to activate and deactivate a stage by an external signal.				--	No
This protection trips in the range from 0.2Un to 1.20Un.it is inhibited for input voltages of less than 20 % Un				--	No
Parameter	Settings	Test 1	Test 2	Test 3	Limits
Trip value [Hz]	47.0	46.99	46.99	46.98	47.0±0.05
Trip time [ms]	100	104.40	100.80	100.60	100±10
Parameter	Settings	Test 1	Test 2	Test 3	Limits
Trip value [Hz]	47.0	47.00	47.00	46.99	47.0±0.05
Trip time [s]	100	100.00	99.98	100.00	100±10

Trip time (0.1s setting)



Trip time (100s setting)

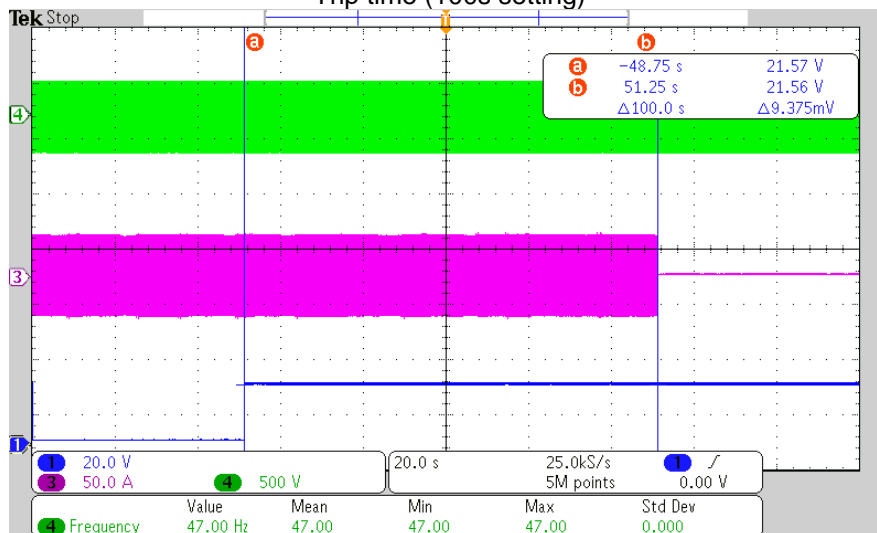
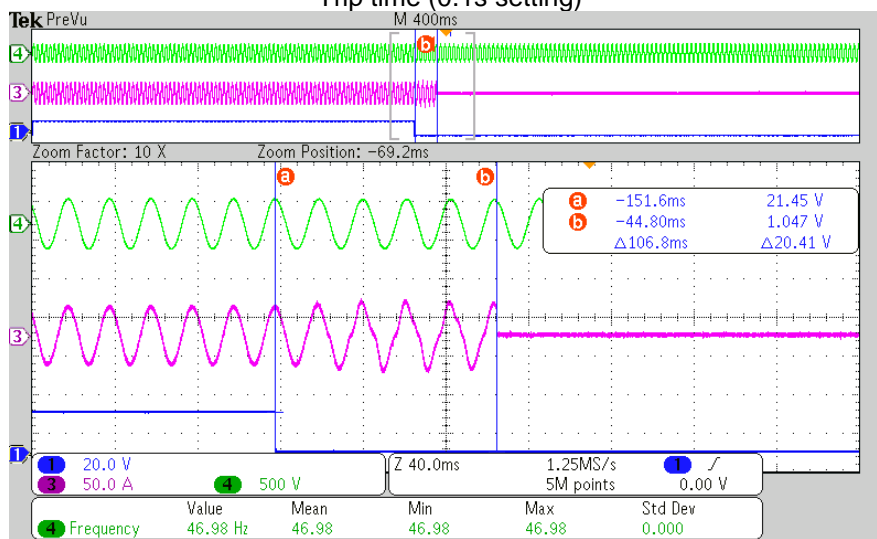

Table 4.9.3 Interface protection					P
Underfrequency threshold stage 2 [81 < <] Adjustment range				Yes	No
Trip value Config. from 47.0 to 50.0Hz (0.1Hz steps)				Yes	--
Trip time Config. from 0.1 to 5s (0.05s steps)				Yes	--
it may be required to have the ability to activate and deactivate a stage by an external signal.				--	No
This protection trips in the range from 0.2Un to 1.20Un.it is inhibited for input voltages of less than 20 % Un				--	No
Parameter	Settings	Test 1	Test 2	Test 3	Limits
Trip value [Hz]	47.0	46.98	46.97	46.98	47.0±0.05
Trip time [ms]	100	106.80	101.70	100.40	100±10
Parameter	Settings	Test 1	Test 2	Test 3	Limits
Trip value [Hz]	47.0	46.99	47.00	46.99	47.0±0.05
Trip time [s]	5	5.02	5.00	5.00	5±0.05

Trip time (0.1s setting)



Trip time (5s setting)

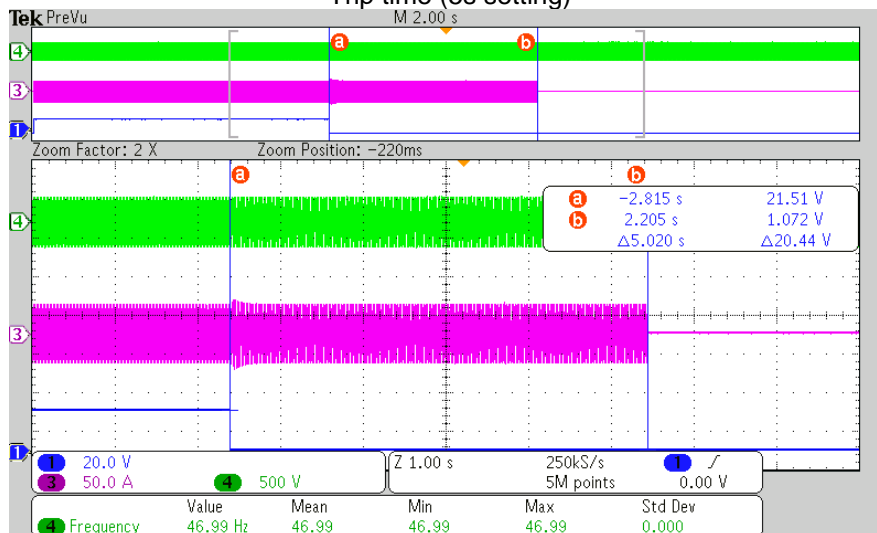
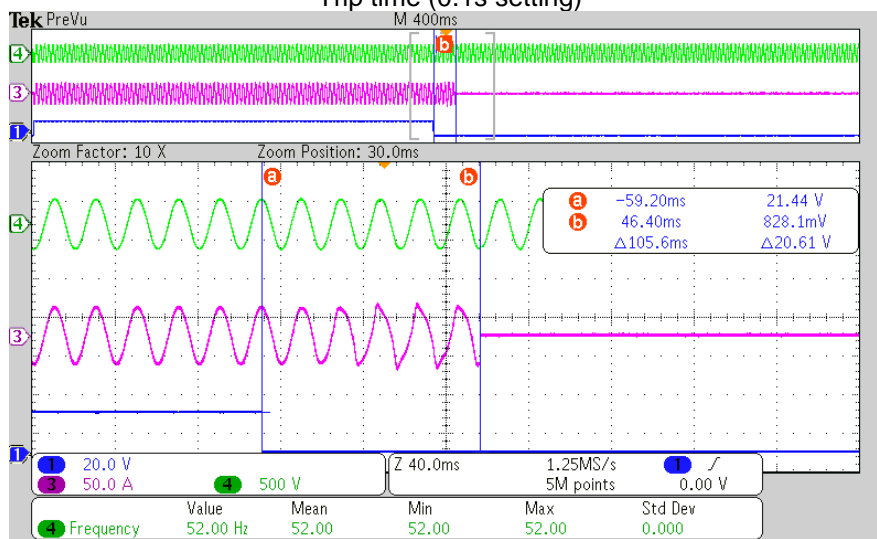

Table 4.9.3 Interface protection					P
Overfrequency threshold stage 1 [81 >] Adjustment range				Yes	No
Trip value Config. from 50.0 to 52.0Hz (0.1Hz steps)				Yes	--
Trip time Config. from 0.1 to 100s (0.1s steps)				Yes	--
it may be required to have the ability to activate and deactivate a stage by an external signal.				--	No
This protection trips in the range from 0.2Un to 1.20Un.it is inhibited for input voltages of less than 20 % Un				--	No
Parameter	Settings	Test 1	Test 2	Test 3	Limits
Trip value [Hz]	52.0	52.00	52.00	52.00	52.0±0.05
Trip time [ms]	100	105.60	100.20	100.60	100±10
Parameter	Settings	Test 1	Test 2	Test 3	Limits
Trip value [Hz]	52.0	52.00	52.00	52.01	52.0±0.05
Trip time [s]	100	100.00	100.00	100.00	100±10

Trip time (0.1s setting)



Trip time (100s setting)

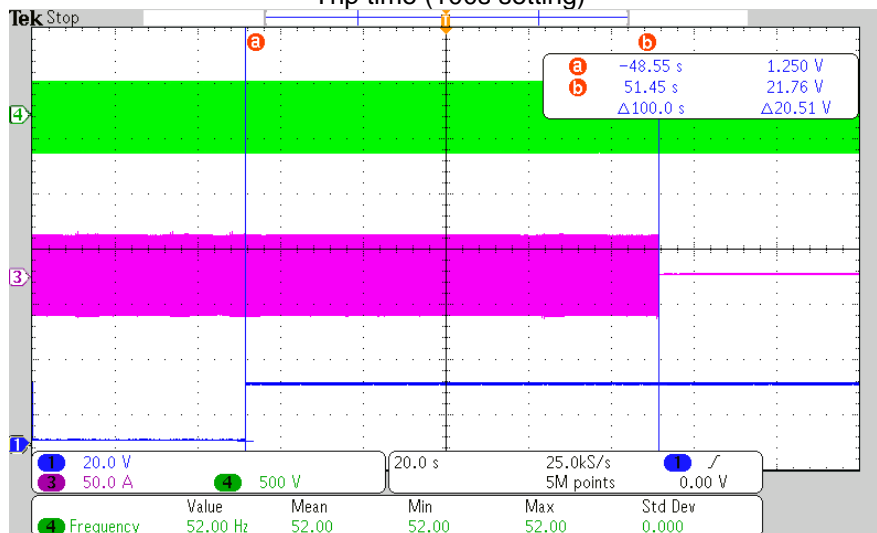
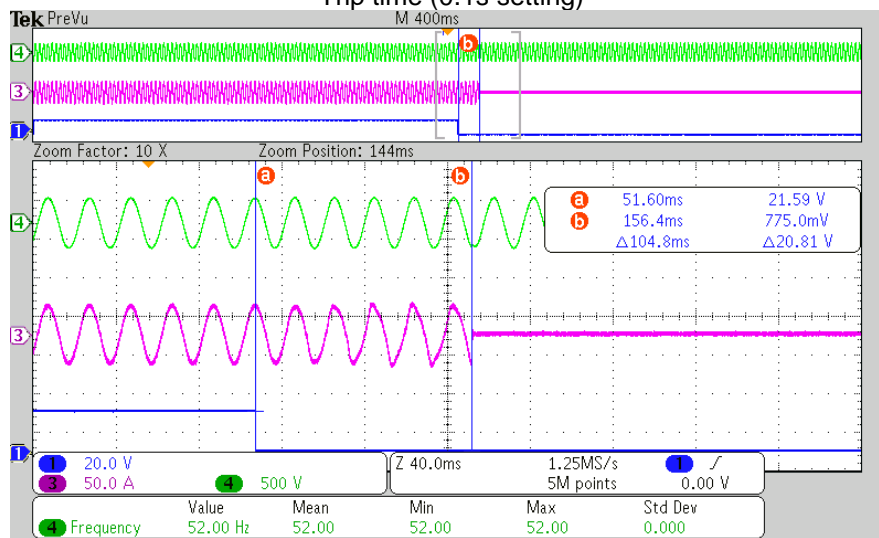
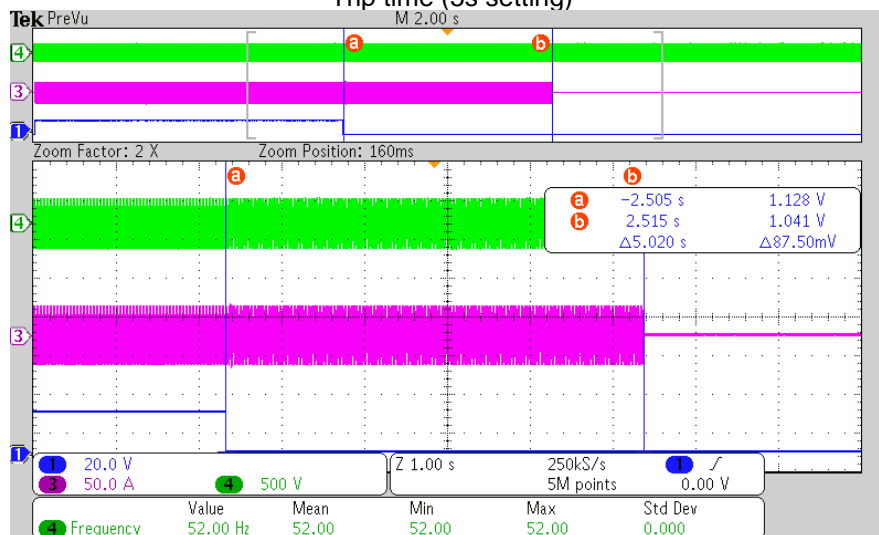

Table 4.9.3 Interface protection					P
Overfrequency threshold stage 2 [81 > >] Adjustment range				Yes	No
Trip value Config. from 50.0 to 52.0Hz (0.1Hz steps)				Yes	--
Trip time Config. from 0.1 to 5s (0.05s steps)				Yes	--
it may be required to have the ability to activate and deactivate a stage by an external signal.				--	No
This protection trips in the range from 0.2Un to 1.20Un.it is inhibited for input voltages of less than 20 % Un				--	No
Parameter	Settings	Test 1	Test 2	Test 3	Limits
Trip value [Hz]	52.0	52.00	52.00	52.01	52.0±0.05
Trip time [ms]	100	104.80	100.40	100.10	100±10
Parameter	Settings	Test 1	Test 2	Test 3	Limits
Trip value [Hz]	52.0	52.00	52.00	52.00	52.0±0.05
Trip time [s]	5	5.02	5.00	4.99	5±0.05

Trip time (0.1s setting)



Trip time (5s setting)



4.9.4 Means to detect island situation									P
No.	PEUT ¹⁾ (% of EUT rating)	Reactive load (% of QL in 6.1.d)1)	PAC ²⁾ (% of nominal)	QAC ³⁾ (% of nominal)	Run on time (ms)	P _{EUT} (W)	Actual Qf	V _{DC}	Remarks ⁴⁾
1.	100	100	0	0	322	6000	0.99	355	Test A at BL
2.	66	66	0	0	300	3960	1.00	270	Test B at BL
3.	33	33	0	0	281	1980	0.98	168	Test C at BL
4.	100	100	-5	-5	304	6000	1.01	355	Test A at IB
5.	100	100	-5	0	289	6000	1.04	355	Test A at IB
6.	100	100	-5	5	212	6000	1.07	355	Test A at IB
7.	100	100	0	-5	277	6000	0.96	355	Test A at IB
8.	100	100	0	5	237	6000	1.01	355	Test A at IB
9.	100	100	5	-5	210	6000	0.92	355	Test A at IB
10.	100	100	5	0	280	6000	0.94	355	Test A at IB
11.	100	100	5	5	282	6000	0.96	355	Test A at IB
12.	66	66	0	-5	222	3960	0.97	270	Test B at IB
13.	66	66	0	-4	228	3960	0.98	270	Test B at IB
14.	66	66	0	-3	230	3960	0.98	270	Test B at IB
15.	66	66	0	-2	280	3960	0.99	270	Test B at IB
16.	66	66	0	-1	236	3960	0.99	270	Test B at IB
17.	66	66	0	1	238	3960	1.00	270	Test B at IB
18.	66	66	0	2	256	3960	1.01	270	Test B at IB
19.	66	66	0	3	254	3960	1.01	270	Test B at IB
20.	66	66	0	4	242	3960	1.02	270	Test B at IB
21.	66	66	0	5	168	3960	1.02	270	Test B at IB
22.	33	33	0	-5	203	1980	0.96	168	Test C at IB
23.	33	33	0	-4	218	1980	0.96	168	Test C at IB
24.	33	33	0	-3	220	1980	0.97	168	Test C at IB
25.	33	33	0	-2	242	1980	0.97	168	Test C at IB
26.	33	33	0	-1	230	1980	0.98	168	Test C at IB
27.	33	33	0	1	263	1980	0.99	168	Test C at IB
28.	33	33	0	2	245	1980	0.99	168	Test C at IB
29.	33	33	0	3	256	1980	1.00	168	Test C at IB
30.	33	33	0	4	200	1980	1.00	168	Test C at IB
31.	33	33	0	5	160	1980	1.01	168	Test C at IB

Remark:

1) PEUT: EUT output power

2) PAC: Real power flow at S1 in Figure 1. Positive means power from EUT to utility. Nominal is the 0 % test condition value.

3) QAC: Reactive power flow at S1 in Figure 1. Positive means power from EUT to utility. Nominal is the 0 % test condition value.

4) BL: Balance condition, IB: Imbalance condition.

4.9.4 Means to detect island situation

P

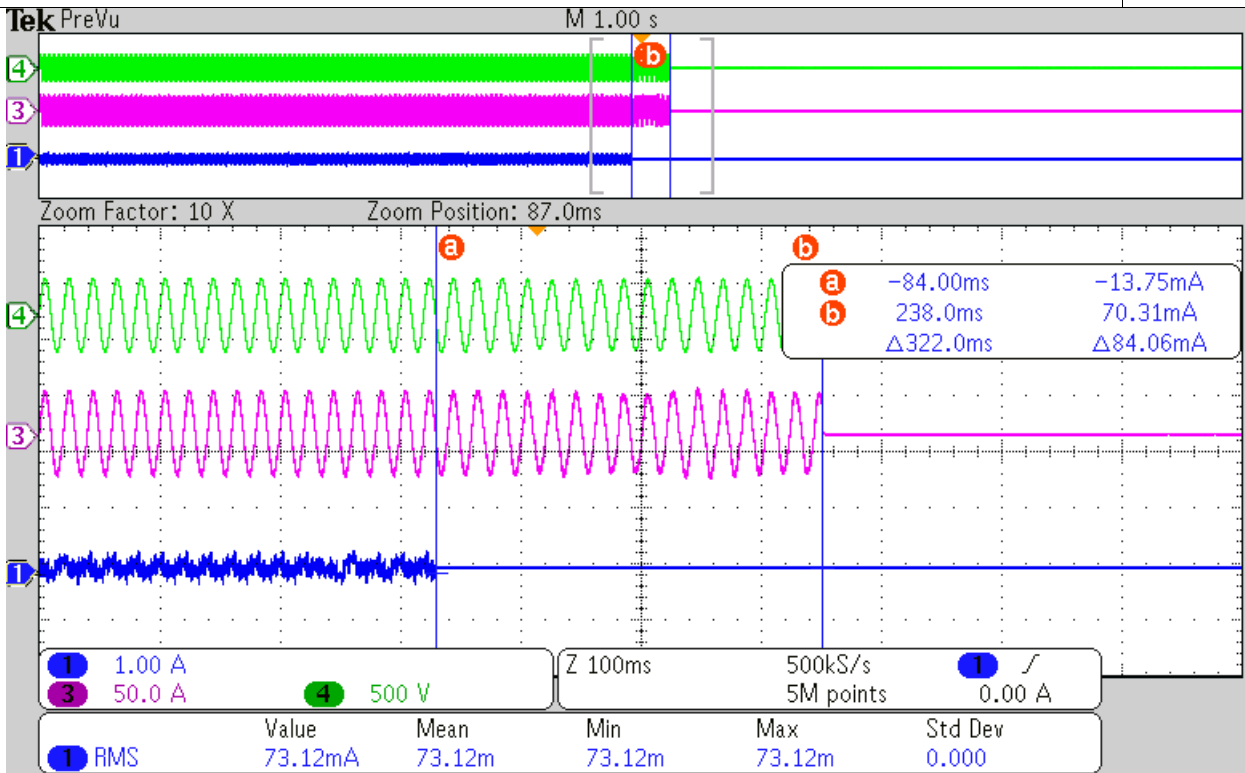

PEUT 100%, PAC 0%, QAC 0%, = 322 ms

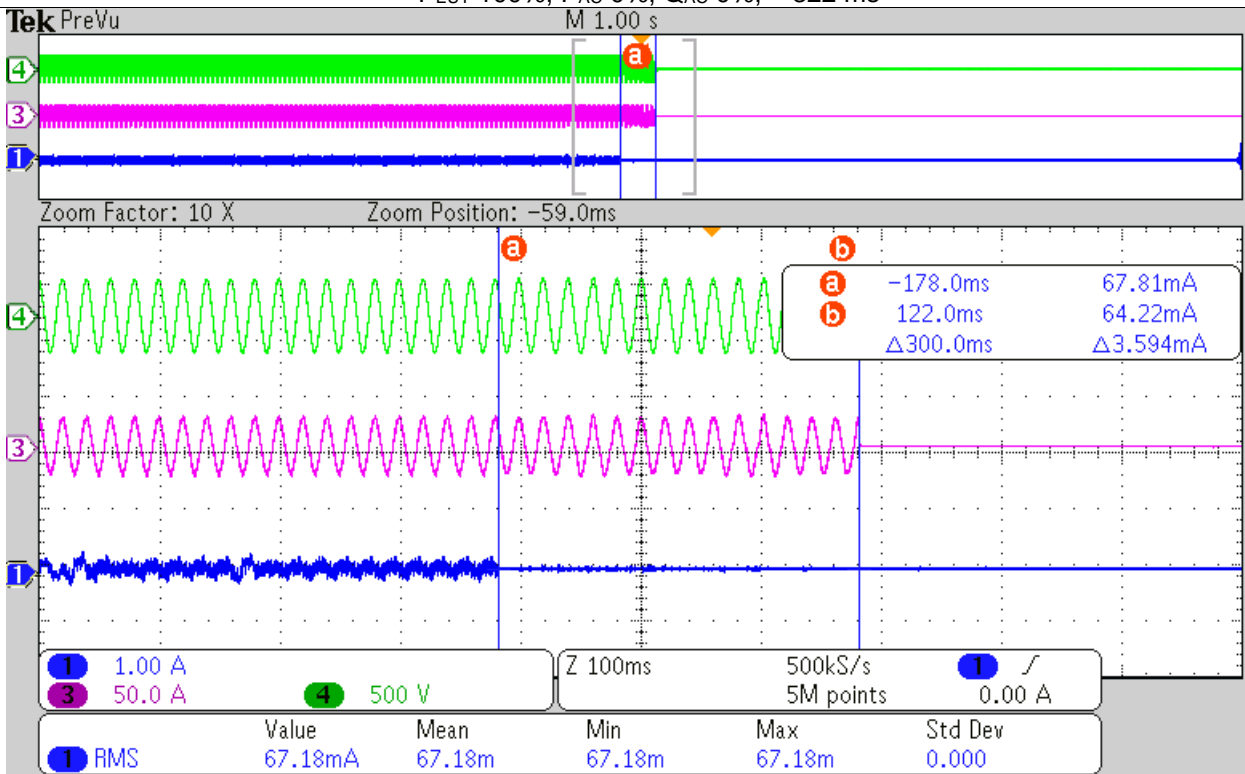

PEUT 66%, PAC 0%, QAC 0%, = 300 ms

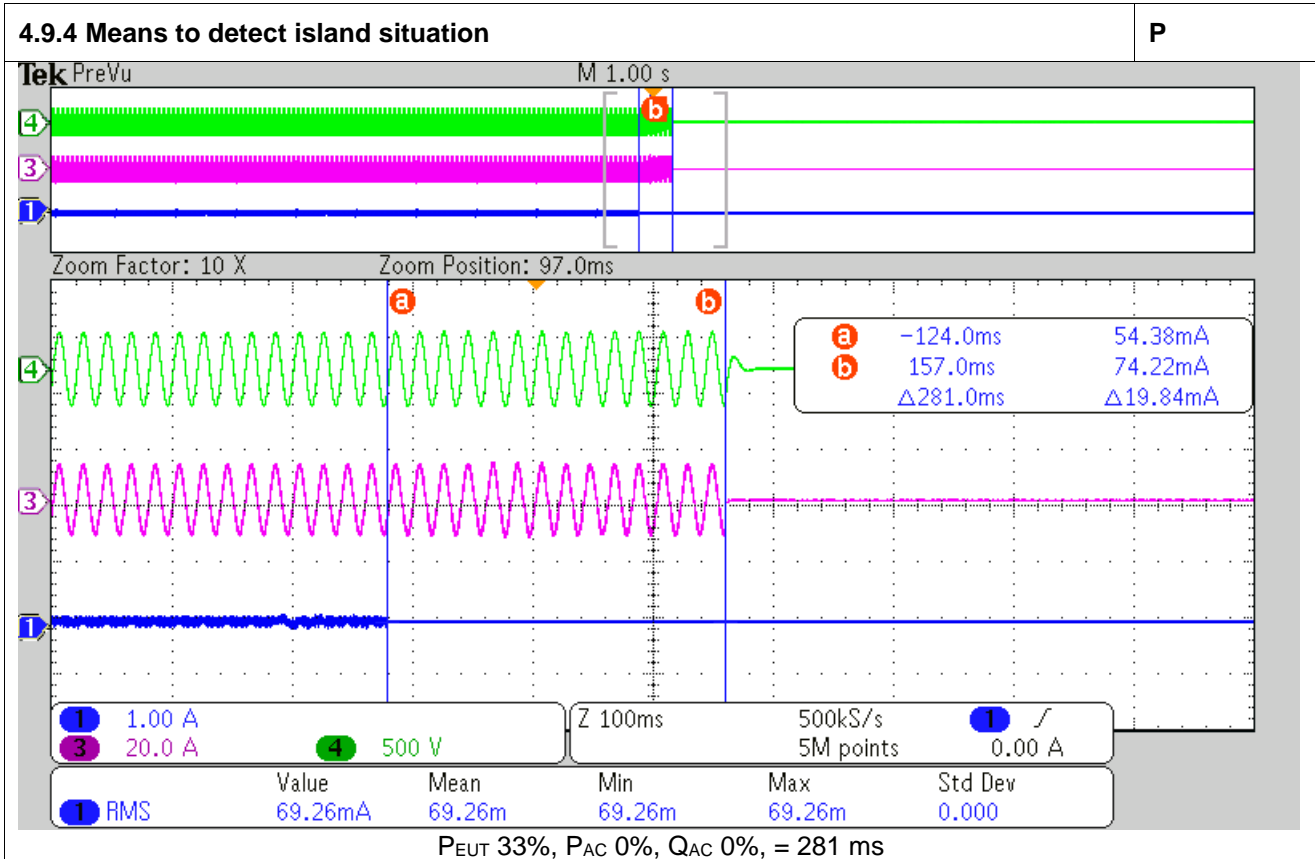

4.10.2 Automatic reconnection after tripping **P**

Parameter	Range	Default setting
Lower frequency	47,0Hz – 50,0Hz	49,5Hz
Upper frequency	50,0Hz – 52,0Hz	50,2Hz
Lower voltage	50% – 100%U _n	85 % U _n
Upper voltage	100% – 120% U _n	110 % U _n
Observation time	10s – 600s	60s
Active power increase gradient	6% – 3000%/min	10%/min

Test sequence after trip	connection	connection allowed	Observation time (s)	Power gradient after Connection (%/min)
Step a)	<49.5Hz	No	--	--
Step b)	≥49.5Hz	Yes	61.0	9.70
Step c)	>50.2Hz	No	--	--
Step d)	≤50.2Hz	Yes	61.0	9.63
Step e)	<195.5V	No	--	--
Step f)	≥195.5V	Yes	61.0	9.78
Step g)	>253V	No	--	--
Step h)	≤253V	Yes	61.0	9.72

Remark: Tested at default setting.

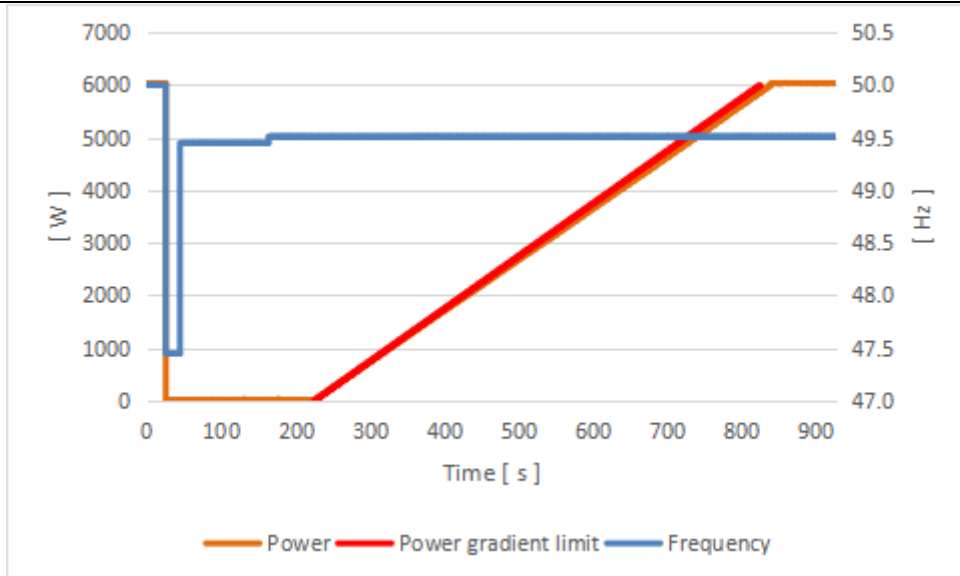

Graph_49.5Hz setting

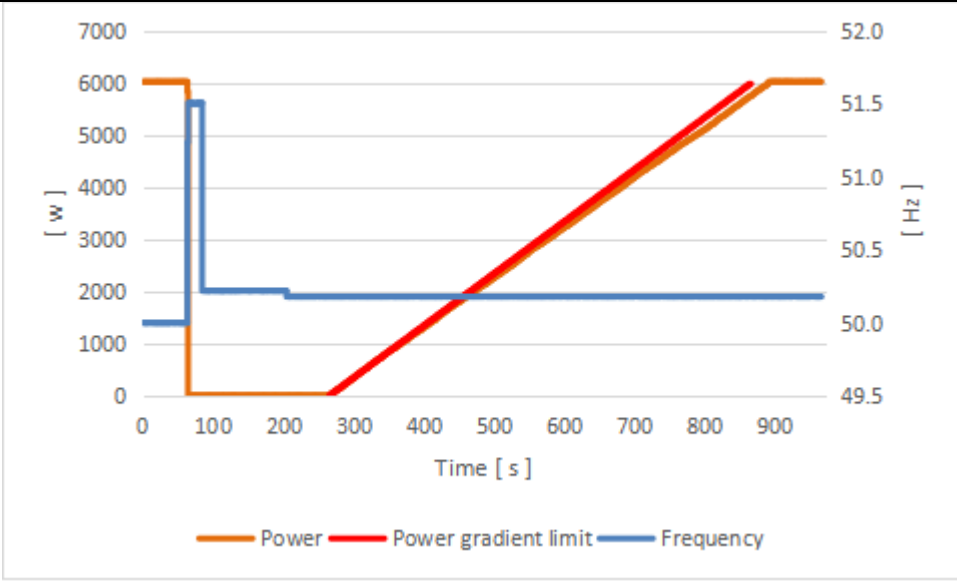
4.10.2 Automatic reconnection after tripping	P
 <p style="text-align: center;">Graph_50.2Hz setting</p>	
 <p style="text-align: center;">Graph_195.5V setting</p>	
 <p style="text-align: center;">Graph_253V setting</p>	

4.10.3 Starting to generate electrical power **P**

Parameter	Range	Default setting
Lower frequency	47,0Hz – 50,0Hz	49,5Hz
Upper frequency	50,0Hz – 52,0Hz	50,1Hz
Lower voltage	50% – 100% U _n	85 % U _n
Upper voltage	100% – 120% U _n	110 % U _n
Observation time	10s – 600s	60s
Active power increase gradient	6% – 3000%/min	disabled

Test result:

Test sequence at normal operation starting	connection	connection allowed	Observation time (s)	Power gradient after Connection (%/min)
Step a)	<49.5Hz	No	--	--
Step b)	≥49.5Hz	Yes	61.0	9.57
Step c)	>50.1Hz	No	--	--
Step d)	≤50.1Hz	Yes	61.0	9.54
Step e)	<195.5V	No	--	--
Step f)	≥195.5V	Yes	61.0	9.78
Step g)	>253V	No	--	--
Step h)	≤253V	Yes	61.0	9.62

Remark: Tested at default setting.

Graph_49.5Hz

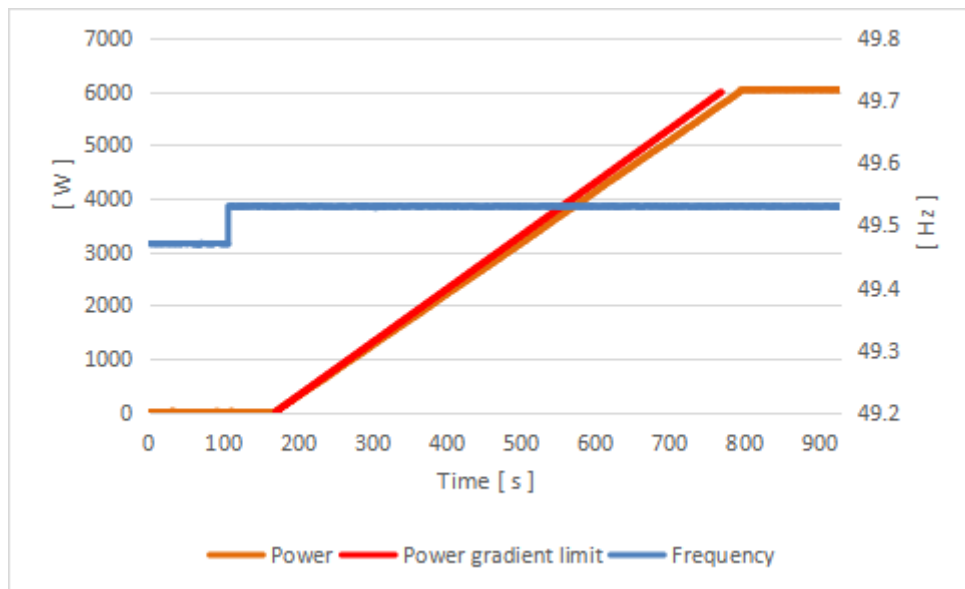

4.10.3 Starting to generate electrical power **P**

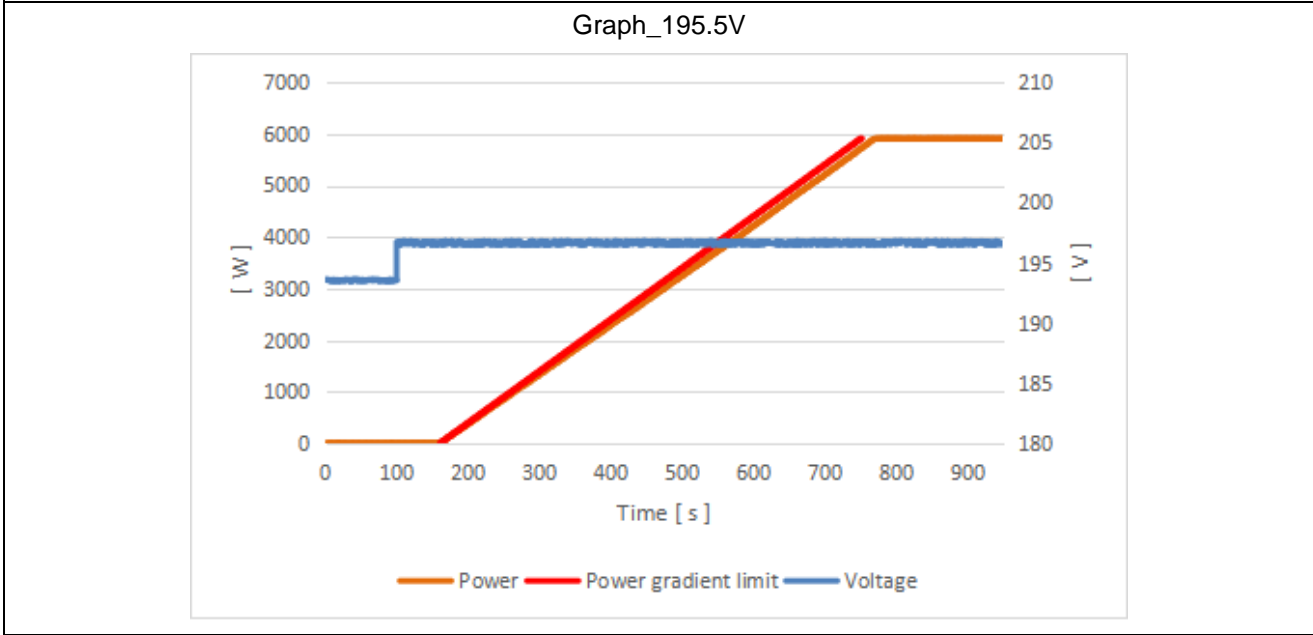
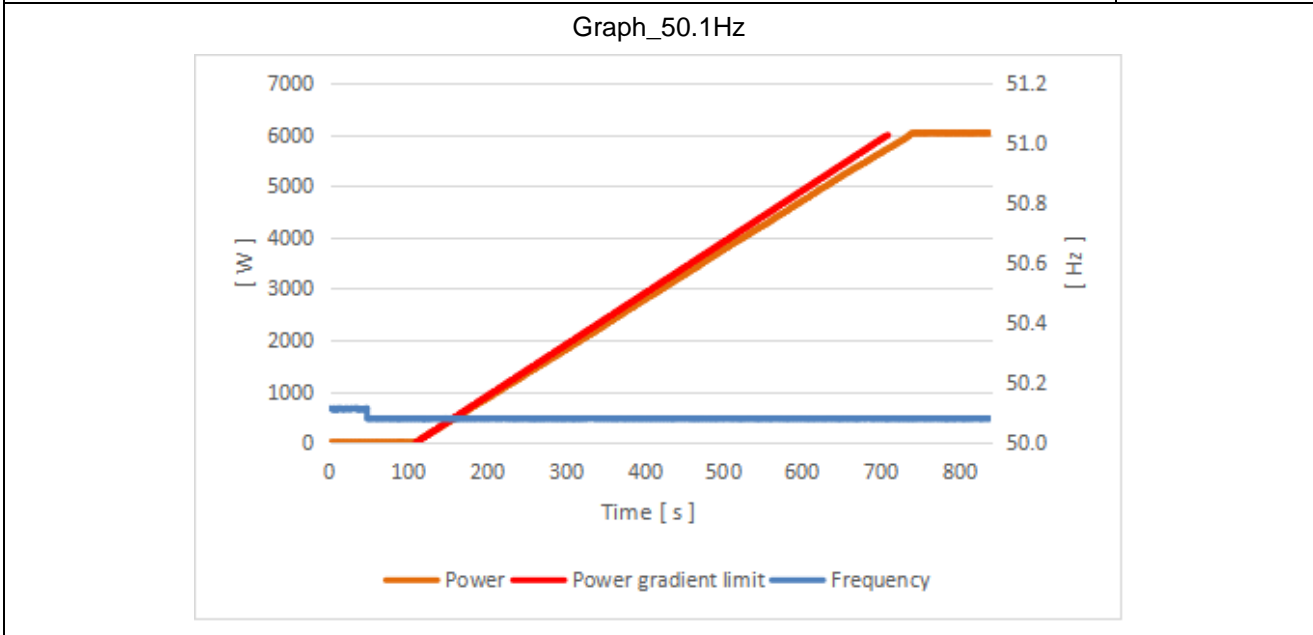

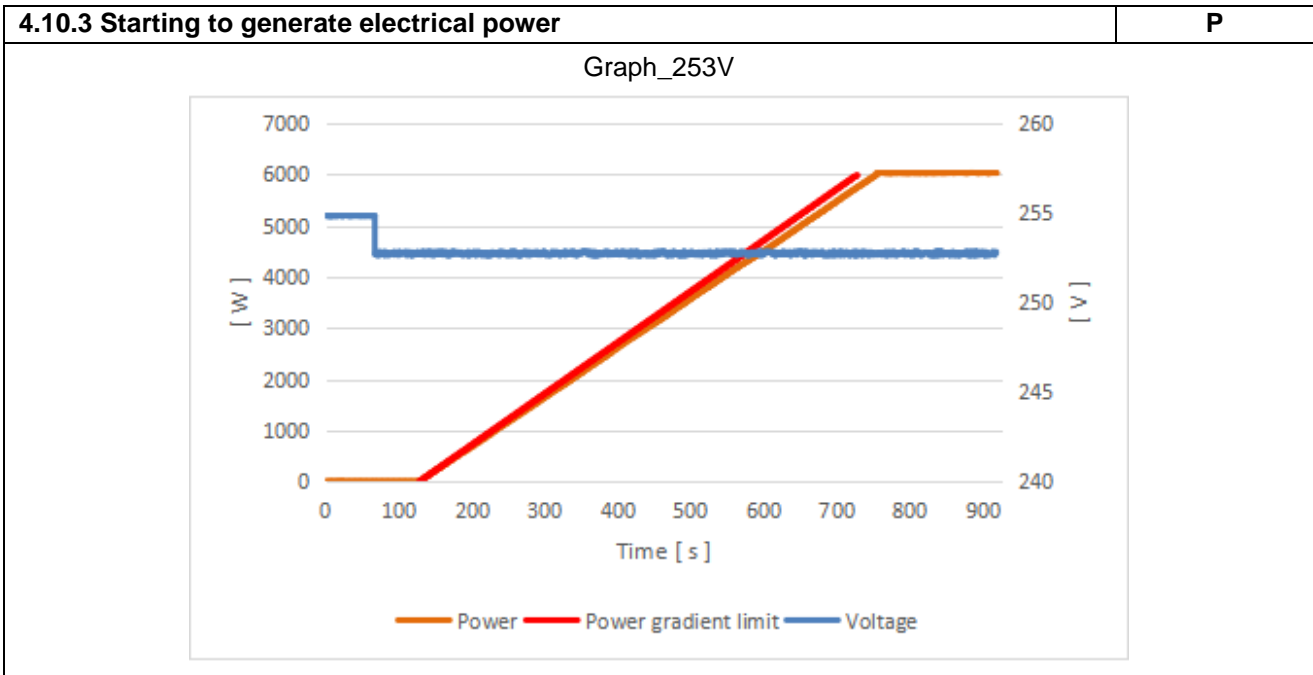

4.11 Active power reduction by setpoint and ceasing active power (Logic interface)							P
String	1	U _{Dc} =	360 Vdc	U _{ac} = U _n	230 Vac	P _{E_{max}} (KW)	6
1 min mean value P/P _n setpoint (%)		P _{measured} (%)		ΔP _{measured} (%)		Limit [%]	
100%		100.10%		0.10%		±5%	
90%		90.24%		0.24%		±5%	
80%		80.23%		0.23%		±5%	
70%		70.27%		0.27%		±5%	
60%		60.14%		0.14%		±5%	
50%		50.15%		0.15%		±5%	
40%		40.32%		0.32%		±5%	
30%		30.27%		0.27%		±5%	
20%		20.39%		0.39%		±5%	
10%		10.42%		0.42%		±5%	
0%		0.29%		0.29%		±5%	
The power gradient for increasing and reducing (%P _n /s)						0.42%P _n /s	
Time for Logic interface (at input port) activated						0.411s	

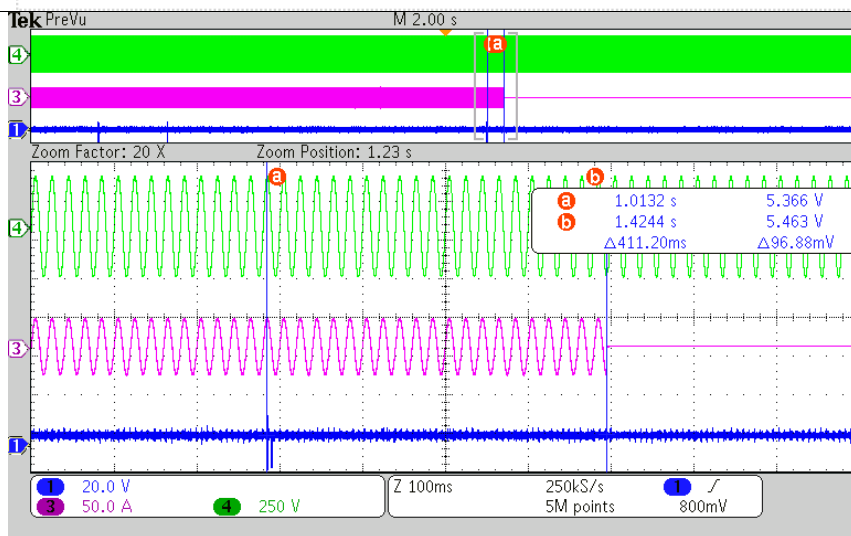
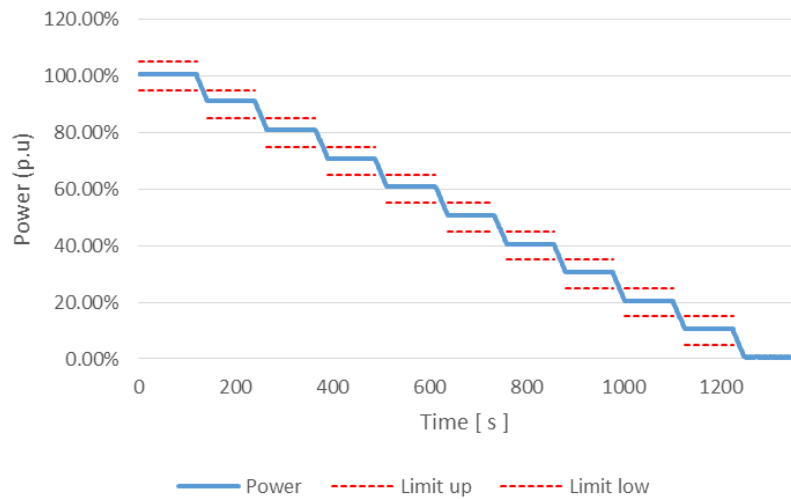

4.13		TABLE: Single fault tolerance				P
No.	Fault	Component No.	Fault point	Duration	Result	
1.	ISO Relay	ALFG1	Short circuit before start up inverter	3min	Unit can't operate, EM: Iso Fault. no danger, no hazard, no fire	
2.	Monitoring Relay - L	K1	Pin3 to Pin4 short circuit before start up inverter	3min	Unit can't operate, EM: GridRelay Fault. no danger, no hazard, no fire	
3.	Monitoring Relay - L	K1	Pin3 to Pin4 open circuit before start up inverter	3min	Unit can't operate, EM: GridRelay Fault. no danger, no hazard, no fire	
4.	Monitoring Relay - N	K3	Pin3 to Pin4 short circuit before start up inverter	3min	Unit can't operate, EM: GridRelay Fault. no danger, no hazard, no fire	
5.	Monitoring Relay - N	K3	Pin3 to Pin4 open circuit before start up inverter	3min	Unit can't operate, EM: GridRelay Fault. no danger, no hazard, no fire	
6.	AC voltage measure1	D4	Pin2-Pin3 Short circuit	3min	Unit shut down, EM: GridOverVolt Fault. no danger, no hazard, no fire	
7.	AC voltage measure1	D4	Pin1-Pin3 Short circuit	3min	Unit shut down, EM: GridOverVolt Fault. no danger, no hazard, no fire	
8.	AC voltage measure2	D10	Pin1-Pin3 Short circuit	3min	Unit can't operate, EM: PSInvHighVoltFault. No damage, no hazard, no fire	
9.	AC voltage measure2	D10	Pin2-Pin3 Short circuit	3min	Unit can't operate, EM: PSInvHighVoltFault. No damage, no hazard, no fire	
10.	AC current measure1	D19	Pin1-Pin3 Short circuit	3min	Unit can't operate, EM: RInvCurAdChaFault. No damage, no hazard, no fire.	
11.	AC current measure1	D19	Pin2-Pin3 Short circuit	3min	Unit can't operate, EM: RInvCurAdChaFault. No damage, no hazard, no fire.	
12.	AC current measure2	D20	Pin1-Pin3 Short circuit	3min	Unit can't operate, EM: SInvCurAdChaFault. No damage, no hazard, no fire.	
13.	AC current measure2	D20	Pin2-Pin3 Short circuit	3min	Unit can't operate, EM: SInvCurAdChaFault. No damage, no hazard, no fire.	
14.	AC current measure3	D22	Pin2-Pin3 Short circuit	3min	Unit can't operate, EM: RUPSInstCurrHighFault. No damage, no hazard, no fire.	
15.	AC frequency measure	R255	Pin1-Pin2 Short circuit	3min	Unit shut down, EM: GridOverFreq Fault. No damage, no hazard, no fire	
16.	V-bus measure	D31	Pin2-Pin3 Short circuit	3min	Unit can't operate, EM: BusAllVoltHwOveFault. No damage, no hazard, no fire.	
17.	DC current measure1	R247	Pin1-Pin2 Short circuit	3min	Unit shut down, EM: Pv1HwOverCurrFault. no danger, no hazard, no fire	
18.	DC current measure2	R248	Pin1-Pin2 Short circuit	3min	Unit shut down, EM: Pv2HwOverCurrFault. no danger, no hazard, no fire	
19.	DC current measure3	R273	Pin1-Pin2 Short circuit	3min	Unit shut down, EM: Pv3HwOverCurrFault. no danger, no hazard, no fire	
20.	T measure	R180	Pin1-Pin2 Short circuit	3min	Unit can't operate, EM: TemperatureAdChanFault. No damage, no hazard, no fire.	
21.	power tube Boost	Q2	Pin2-Pin3 Short circuit before start up	3min	Unit can not start up, No damage, no hazard, no fire.	

4.13 TABLE: Single fault tolerance					P
22.	Diode	D2	Short circuit	3min	Unit normal operation, No danger, no hazard, no fire
23.	power tube IGBT	QA5	Pin2-Pin3 Short circuit before start up	3min	Unit can't operate, EM: InvOpenTestErr. No danger, no hazard, no fire
24.	power tube IGBT	QA6	Pin2-Pin3 Short circuit before start up	3min	Unit shut down, EM: InvOpenTestErr. No damage, no hazard, no fire
25.	GFCI check	--	Short circuit	3min	Unit shut down, EM: LeakCurrFault. No damage, no hazard, no fire
26.	Bus cap	C208	Pin1-Pin2 Short circuit before start up	3min	Unit can not start up, No damage, no hazard, no fire.
4.4.4.4 Transformer short circuit tests					
27.	Transformer short circuit tests	T4	Pin22-Pin24 Short circuit	10min	Unit can not start up, No damage, no hazard, no fire.
28.	Transformer short circuit tests	T4	Pin32-Pin36 Short circuit	10min	Unit can not start up, No damage, no hazard, no fire.
29.	power tube MOS-SPS	Q-MOS1	G-D Short circuit	10min	SPS no output, no danger, no hazard, no fire
30.	power tube MOS-SPS	Q-MOS1	D-S Short circuit	10min	SPS no output, no danger, no hazard, no fire
4.4.4.5 Output short circuit					
31.	Output L to N	--	short circuit	3min	Unit shut down, EM: GridUnderVoltFault. No damage, no hazard, no fire
32.	Output L to PE	--	short circuit	3min	Unit shut down, EM: GridLossFault. No damage, no hazard, no fire
4.4.4.6 Backfeed current test for equipment with more than one source of supply					
33.	DC	--	--	10min	Vac=0, V _{BAT} =0
34.	AC	--	--	10min	Vdc=0, V _{BAT} =0
35.	BAT	--	--	10min	Vdc=0, Vac=0
36.	BAT	--	--	10min	Vdc=0, Vac=0
4.4.4.7 Output overload					
37.	Overload	--	Output overload (110%)	30 min	Unit normal operation, No damage, no hazard, no fire
4.4.4.8 cooling system failure test					
38.	Cooling system failure – Blanketing test	--	Put the unit to box	2Hour	1 hour power run at 50%
4.4.4.11 Reverse d.c. connections					
39.	PV+ to PV-	--	Reverse polarity	3min	Unit can not start up, no danger, no hazard, no fire
4.4.4.13 Mis-wiring with incorrect phase sequence or polarity					
40.	Output L - N	--	Reverse polarity before start up	3min	Unit normal operation. No damage, no hazard, no fire.

4.13	TABLE: Single fault tolerance	P
<p>Remarks:</p> <p>Abbreviations APS: auxiliary power supply, EM: error message, EUT: equipment under test, SC short circuit, OP: open circuit, O/L: Overloaded EUT shut down: EUT not connect to Grid, cease to export power to Grid, the relay is opened. EUT standby: EUT connect to Grid, cease to export power to Grid, the relay is closed.</p> <p>During the test: Fire can not propagate beyond the EUT. Equipment shall not emitt molten metal. Enclosures shall not deform to cause non-compliance with the standard. Dielectric test is made on RI and BI between Pri. circuit and protective earthing terminal after the test. No Backfeed voltage on the test</p>		

Annex B Photos

Front



Back



Annex B Photos

Left



Right



Annex B Photos

Top



Bottom



Annex B Photos

Internal

